



**LIGHT^{MY}
BRICKS**



**LEGO® DAGOBAH JEDI TRAINING
DIORAMA #75330**

INSTALLATION GUIDE

Light My Bricks



LEGO DAGOBAH JEDI TRAINING DIORAMA 75330 INSTALLATION GUIDE

Hi There!

We're here to help you get started on the LEGO Dagobah Jedi Training Diorama 75330 Light Kit.

This PDF details the instructions for the LED light kit only.

If you run into any issues, please refer to the troubleshoot-ing section towards the end of this guide.

Have fun and enjoy!

INSTALLATION GUIDE

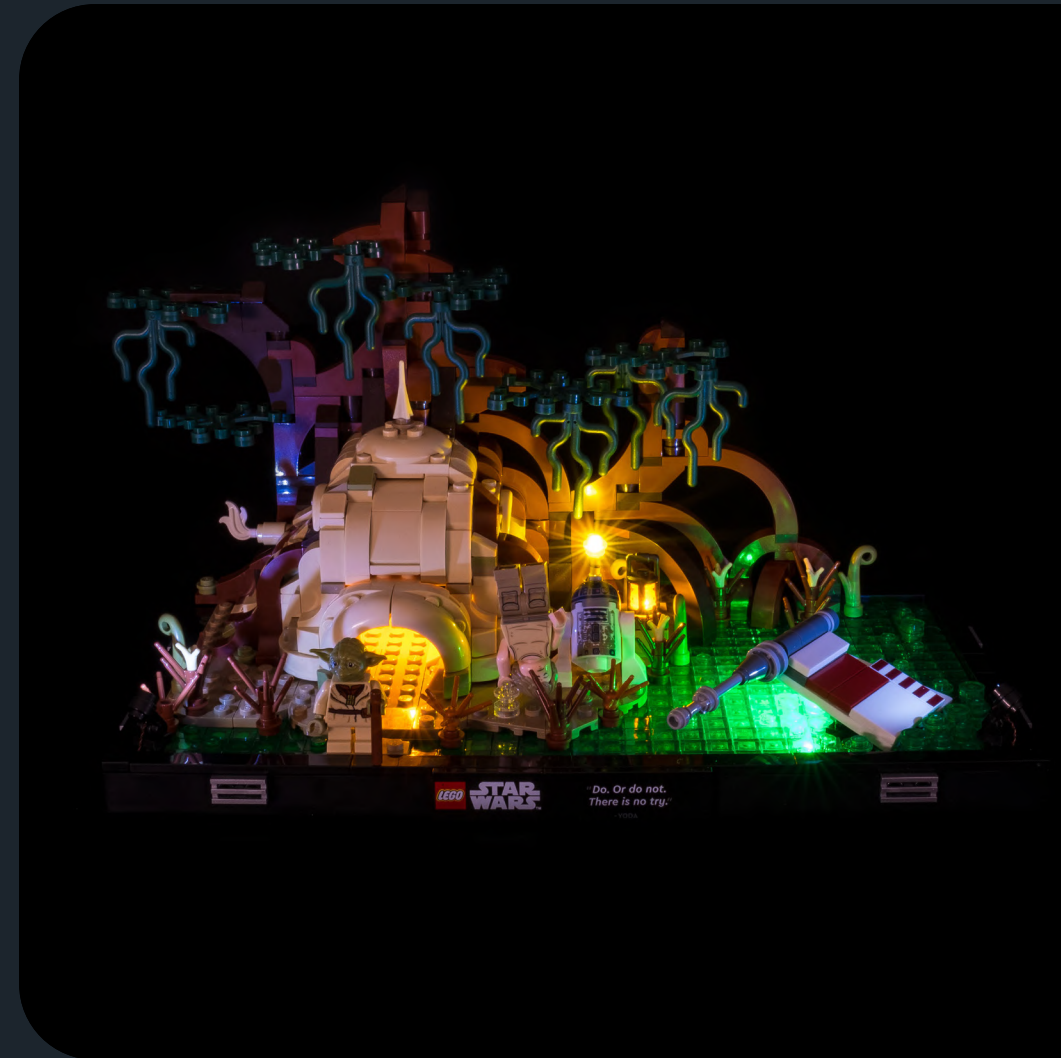



PACKAGE CONTENTS:



- 1 x Orange 30cm Large Bit Light
- 1 x Green 30cm Large Bit Light
- 2 x Cool White 30cm Bit Light
- 2 x White 30cm Bit Light



- 1 x 6-Port Expansion Board
- 1 x Pulse Effects Board
- 4 x Adhesive Squares



- 1 x 5cm Connecting Cable



- 1x USB Power Cable
(Power Source not Included)

ASSORTED BRICKS:



- 1 x Round Plate 2x2 w/ Rounded Bottom - Trans Clear
- 4 x Round Plate 1x1 w/ Open Stud - Black
- 2 x Mod Plate 1x1 w/ Handle - Black
- 2 x Black 1x1 Tile w/ Clip Rounded Edge

Contents

Before You Begin	5
Blueprint	8
Instructions	9
Final Product	24
Troubleshooting	25
Contact	30

Before You Begin

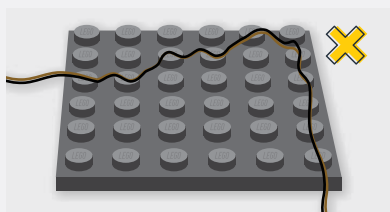

Laying cables in between and underneath bricks

Cables can fit in between and underneath LEGO® bricks, plates, and tiles providing they are laid correctly between the LEGO® studs. Do NOT forcefully join LEGO® together around cables; instead ensure they are laying comfortably in between each stud.

CAUTION: Forcing LEGO® to connect over a cable can result in damaging the cable and light.

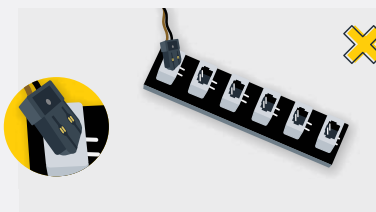

Connecting Cable Connectors To Expansion Boards

Take extra care when inserting connectors to ports of Expansion Boards. Connectors can be inserted only one way. With the expansion board facing up, look for the soldered “=” symbol on the left side of the port. The connector side with the wires exposed should be facing toward the soldered “=” symbol as you insert into the port. If a plug won’t fit easily into a port connector, do not force it.

Incorrectly inserting the connector can result in bent pins inside the port or possible overheating of the expansion board when connected.

Before You Begin



Connecting Cable Connectors To Strip Lights

Take extra care when inserting connectors to ports on the Strip Lights. Connectors can be inserted only one way. With the Strip Light facing up, ensure the side of the connector with the wires exposed is facing down. If a plug won't fit easily into a port connector, don't force it. Doing so will damage the plug and the connector.



Connecting Micro Cable Connectors To Micro Expansion Board Ports

Take extra care when inserting the micro connectors to micro ports of Micro Expansion Boards. Connecting Micro Bit Lights to Micro Expansion Boards is similar to connecting lights and cables to Strip Lights. With the expansion board facing up, ensure the side of the connector with the wires exposed is facing down. If a plug won't fit easily into a port connector, do not force it. Use your fingernail to push the plastic part of the connector to the micro port.

Before You Begin

Installing Bit Lights Under Lego® Bricks And Plates

When installing Bit Lights under LEGO® pieces, ensure they are placed the correct way up (Yellow LED component exposed). You can either place them directly on top of LEGO® studs or in between.

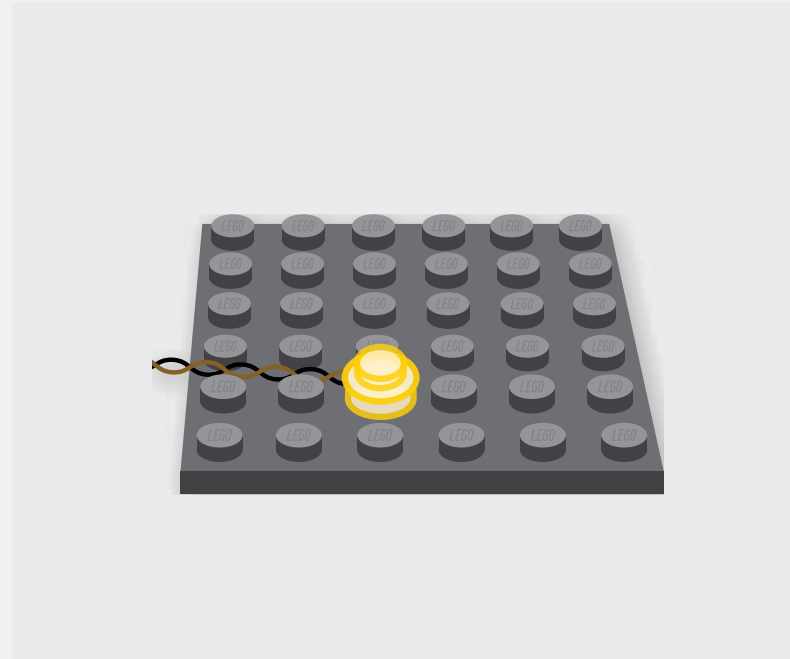

BLUEPRINT

Dagobah Jedi Training Diorama

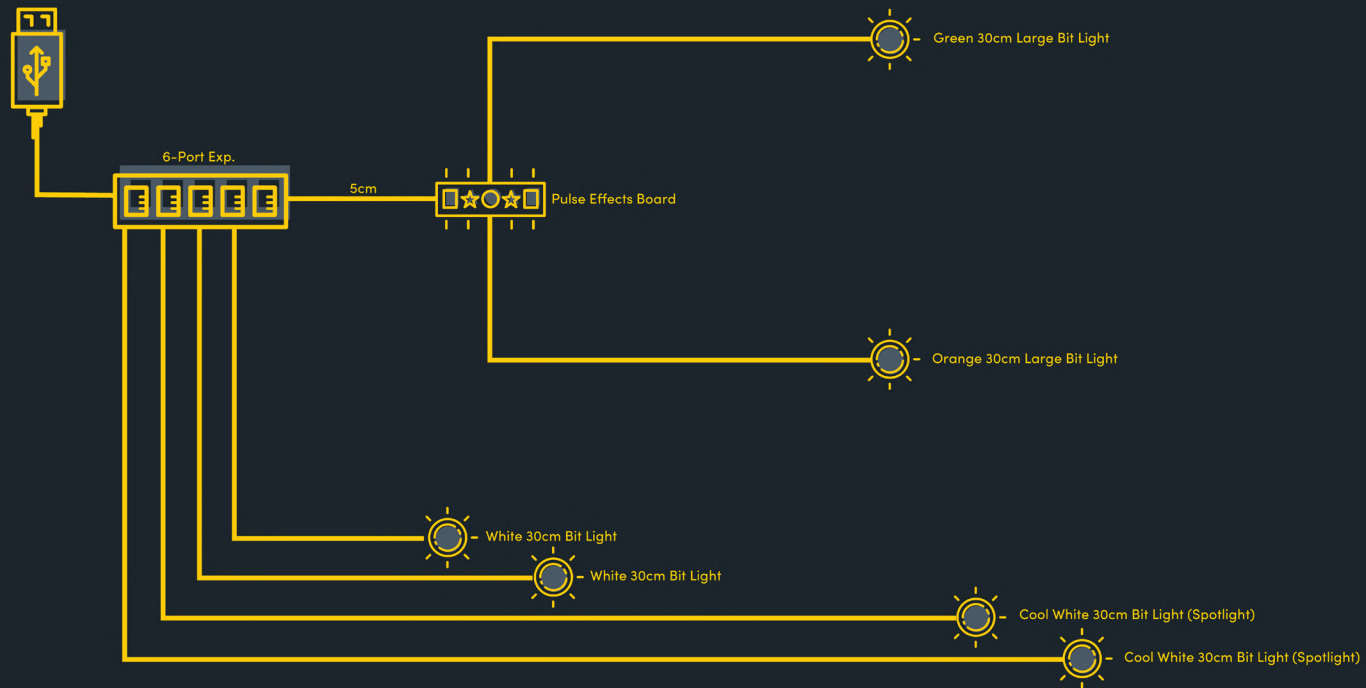



INSTRUCTIONS

To ensure a smooth installation of your light kit, please read and follow each step carefully. If you run into any issues, please refer to the online troubleshooting guide.

	LEGEND:		DISCONNECT		CONNECT / RECONNECT		TURN / FLIP		DIRECTIONAL		TWIST / BRAID		POWER ON / TEST
	LEGENDE:		TRENNEN		VERNINDEN / WIEDERVERBINDEN		WENDEN / KIPPEN		DIRECTIONAL		DREHEN / VERDREHEN		EINSCHALTEN / TESTEN
	LÉGENDE:		DÉCONNECTER		CONNECTER / RECONNECTER		TOUR / INCLINAISON		DIRECTIONNEL		TORSION / TRESSER		POWER ON / TEST
	LEGGENDA:		SCOLLEGARE		CONNETTI / RICONNETTI		ROTARE / INCLINARE		DIREZIONALE		TWIST / TRECCIA		POWER ON / TEST

1



2

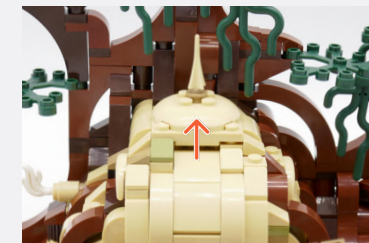

Legend



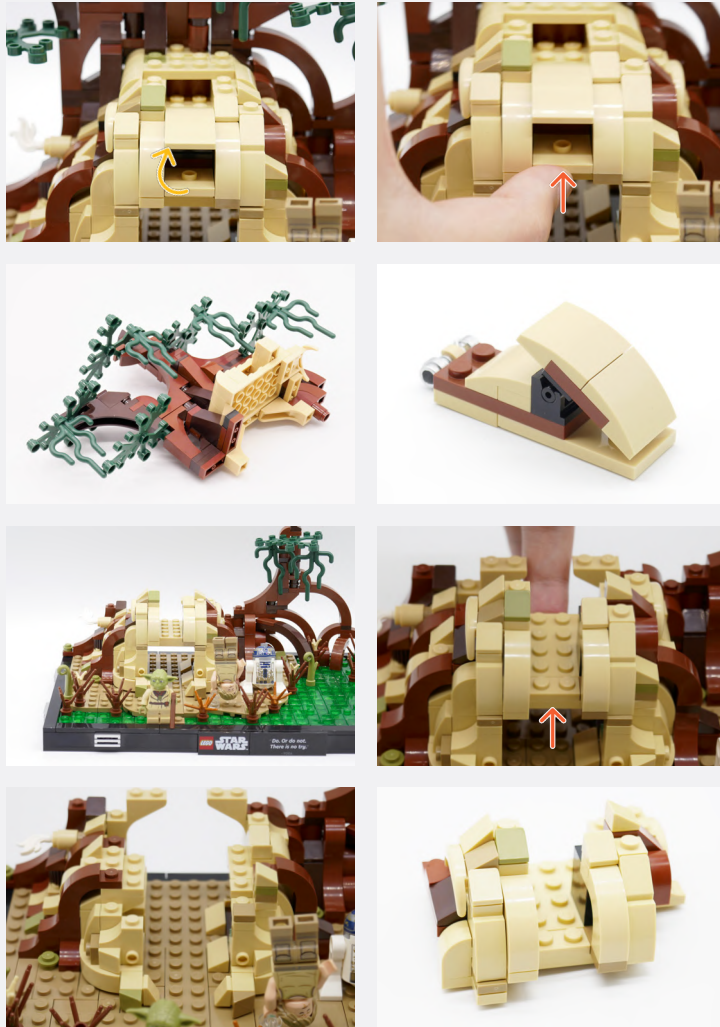

3

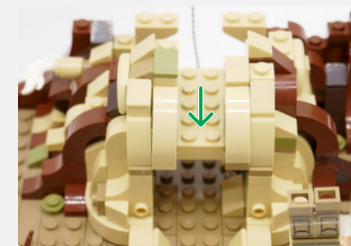
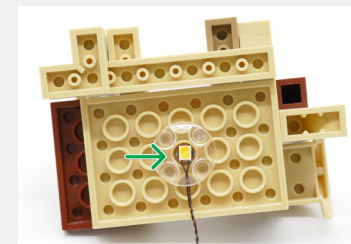
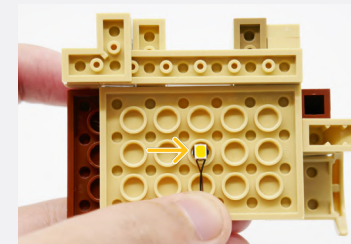
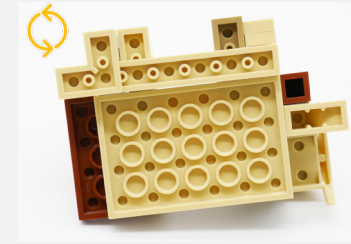

Legend

- DISCONNECT
- CONNECT / RECONNECT
- TURN / FLIP
- DIRECTIONAL
- TWIST / BRAID
- POWER ON TEST
- NOTE ICON



4

The Pulse Effects can be changed on the Board at any time by adjusting the switch to the left, middle or right.

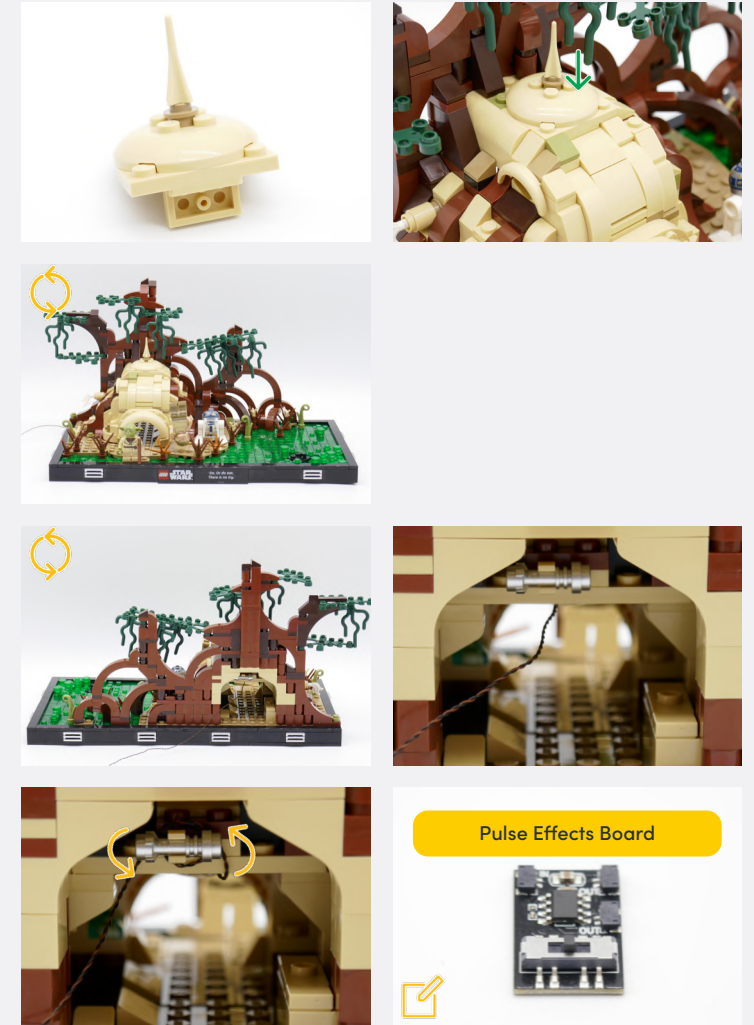

Legend DISCONNECT CONNECT / RECONNECT TURN / FLIP DIRECTIONAL TWIST / BRAID POWER ON TEST NOTE ICON

✍️ Connect the Orange 30cm Large Bit Light to the 'OUT' port of the Pulse Effects Board.

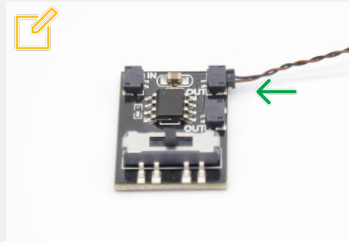
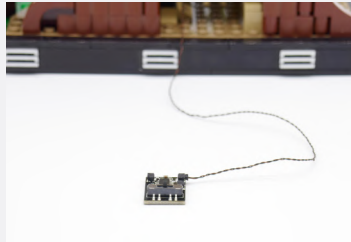

✍️ Connect the 5cm Connecting Cable to the 'IN' port of the Pulse Effects Board.

5cm Connecting Cable

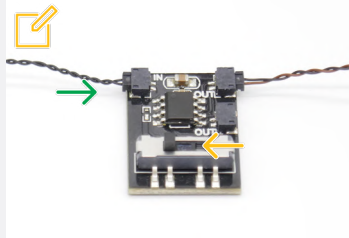

6-Port Expansion Board

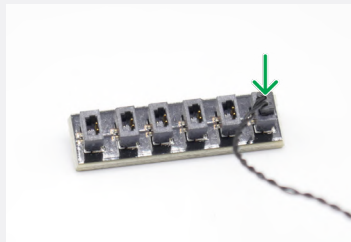
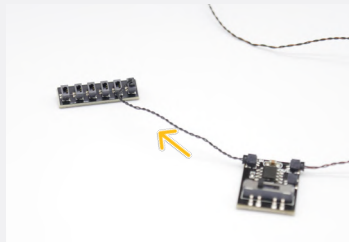
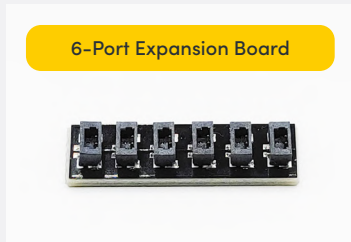

5

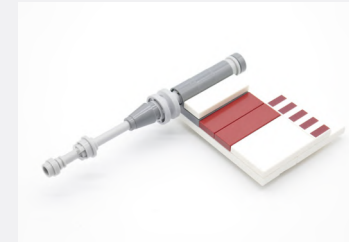

Green 30cm Large Bit Light

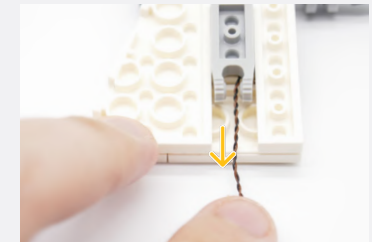
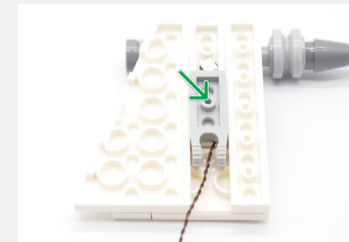
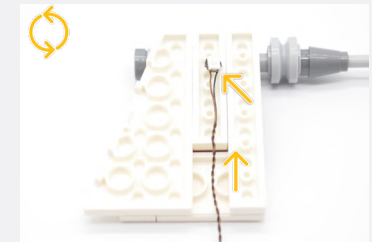

Legend → DISCONNECT → CONNECT / RECONNECT ↻ TURN / FLIP → DIRECTIONAL ↻ TWIST / BRAID * POWER ON TEST ✍️ NOTE ICON

6

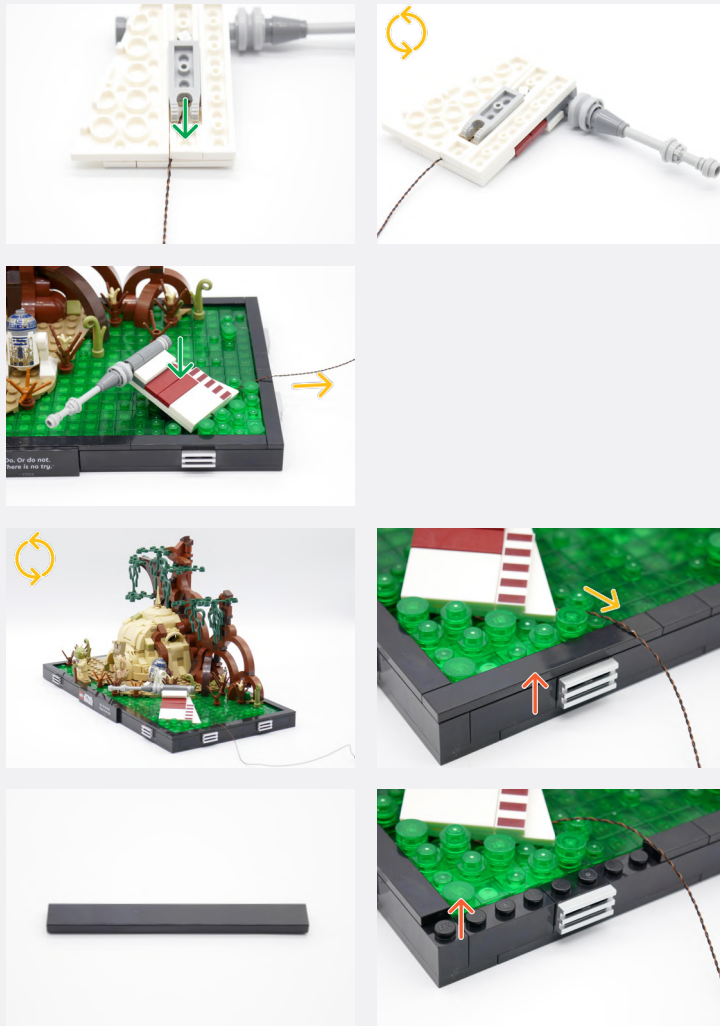

7

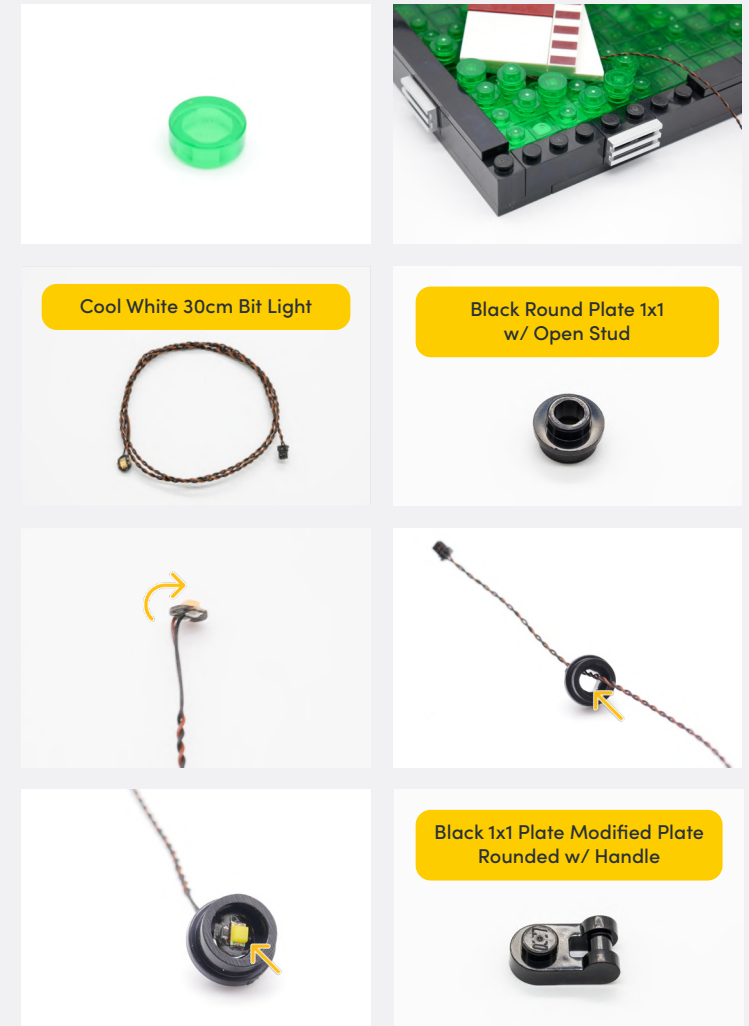

Legend

- DISCONNECT
- CONNECT / RECONNECT
- ↻ TURN / FLIP
- DIRECTIONAL
- ↻↻ TWIST / BRAID
- ✳ POWER ON TEST
- 📝 NOTE ICON

8

Black 1x1 Tile w/ Clip Rounded Edges



Black Round Plate 1x1 w/ Open Stud

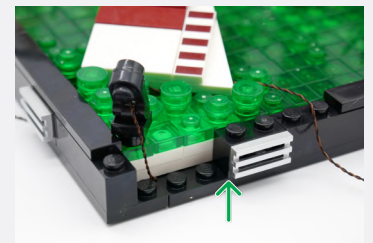
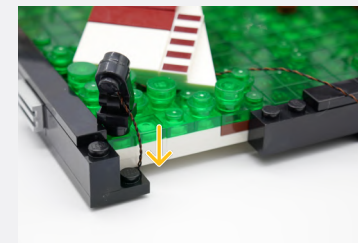
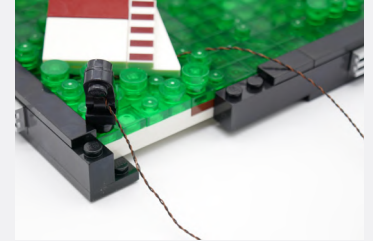
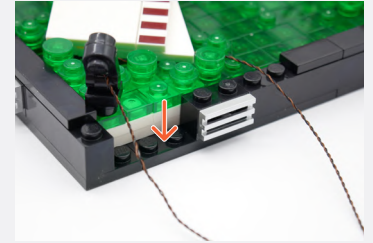
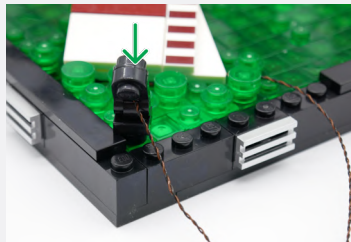

Legend → DISCONNECT → CONNECT / RECONNECT ↻ TURN / FLIP → DIRECTIONAL ↻ TWIST / BRAID ✨ POWER ON TEST 📝 NOTE ICON



9

Pull both cables towards the back of the set

Connect the Green 30cm Large Bit Light (shorter cable) to the 'OUT' port of the Pulse Effects Board

Connect the Spotlight (longer cable) to the 6-Port Expansion Board

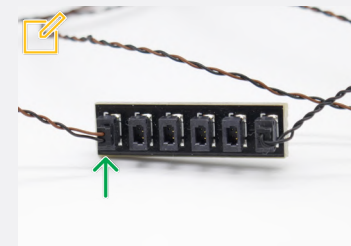
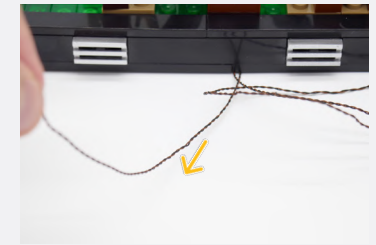
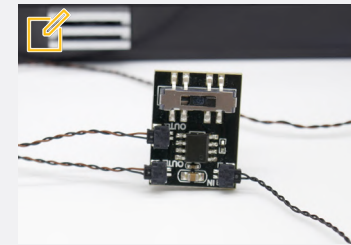
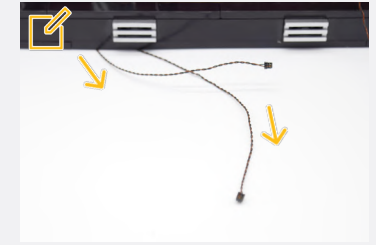

Legend DISCONNECT CONNECT / RECONNECT TURN / FLIP DIRECTIONAL TWIST / BRAID POWER ON TEST NOTE ICON

10

Cool White 30cm Bit Light



Black Round Plate 1x1 w/ Open Stud



Black 1x1 Plate Modified Plate Rounded w/ Handle



Black 1x1 Tile w/ Clip Rounded Edges



11

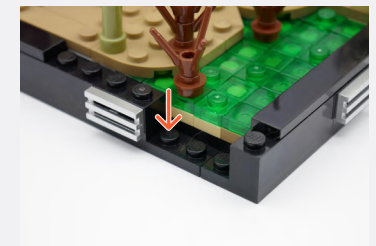

Legend

- DISCONNECT
- CONNECT / RECONNECT
- TURN / FLIP
- DIRECTIONAL
- TWIST / BRAID
- POWER ON TEST
- NOTE ICON



12



Legend → DISCONNECT → CONNECT / RECONNECT ↻ TURN / FLIP → DIRECTIONAL ↻ TWIST / BRAID ✨ POWER ON TEST 📝 NOTE ICON

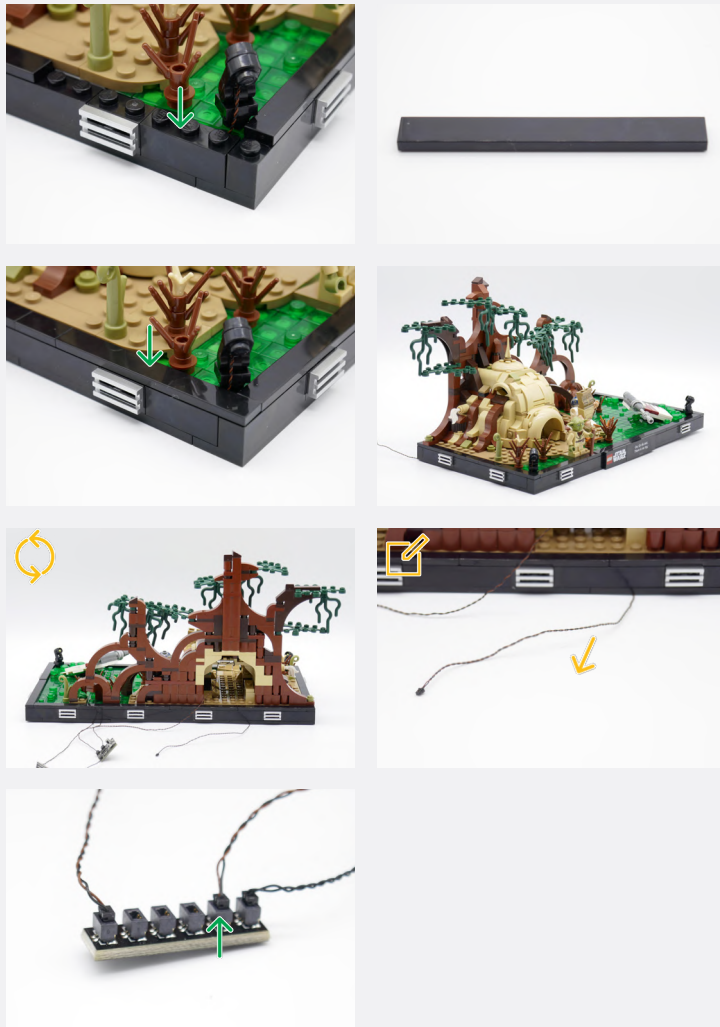

Pull the Spotlight cable towards the back of the set

13

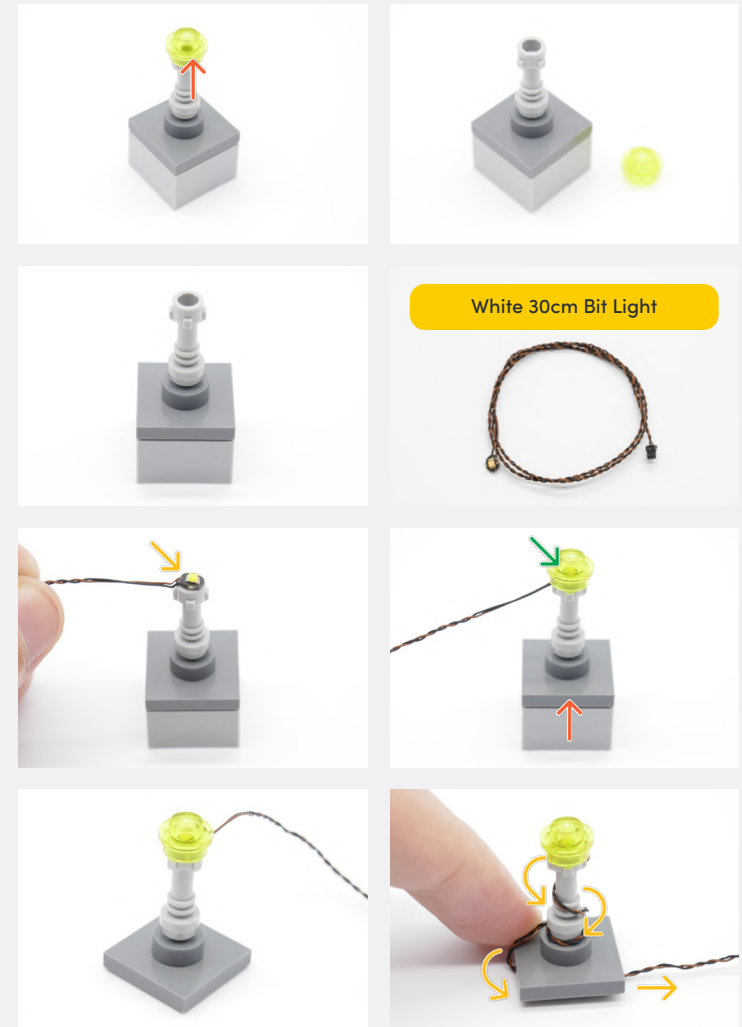

White 30cm Bit Light

Legend DISCONNECT CONNECT / RECONNECT TURN / FLIP DIRECTIONAL TWIST / BRAID POWER ON TEST NOTE ICON

14

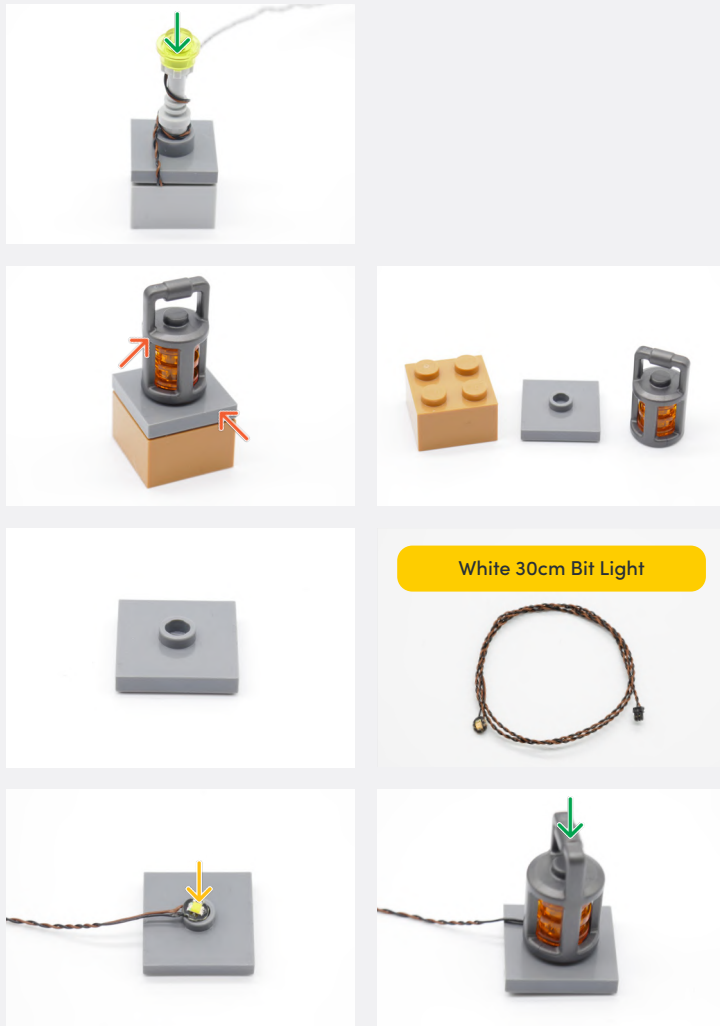

15

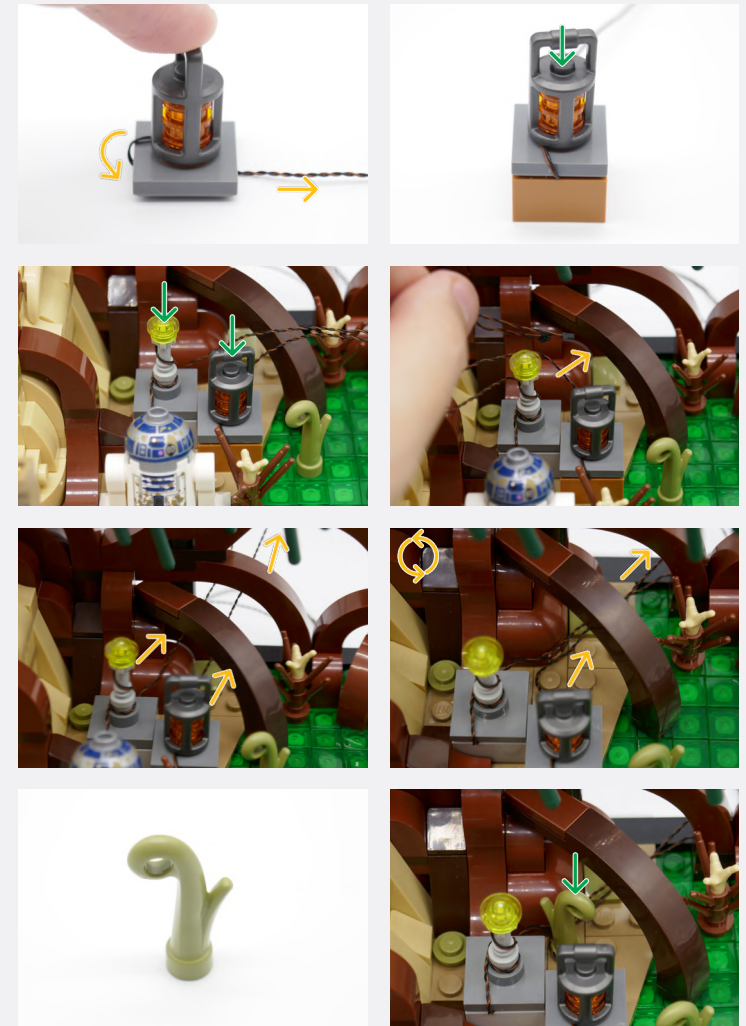

Legend

- DISCONNECT
- CONNECT / RECONNECT
- ↻ TURN / FLIP
- DIRECTIONAL
- ↻↻ TWIST / BRAID
- ✳ POWER ON TEST
- 📝 NOTE ICON

16

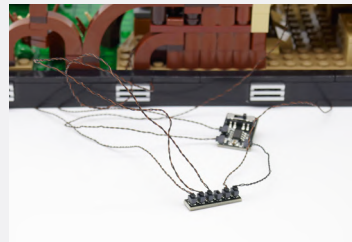
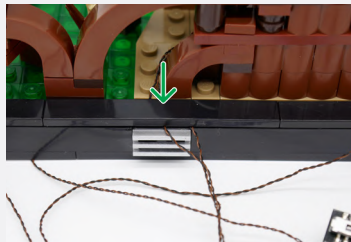
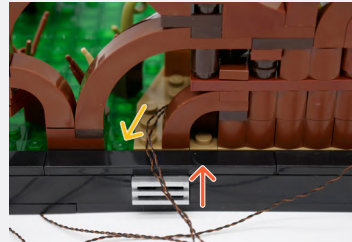

Connect both White 30cm Bit Lights to the 6-Port Expansion Board

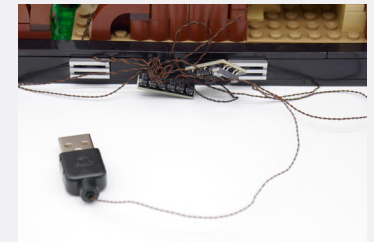
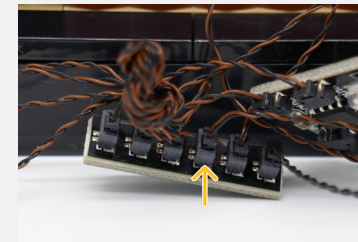
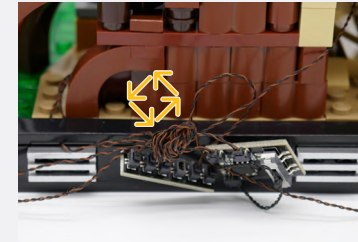
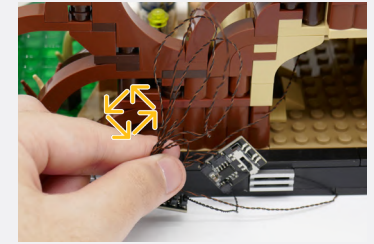
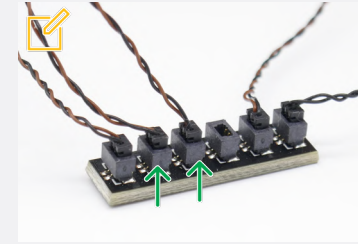

Legend DISCONNECT CONNECT / RECONNECT TURN / FLIP DIRECTIONAL TWIST / BRAID POWER ON TEST NOTE ICON

17

2x Adhesive Squares

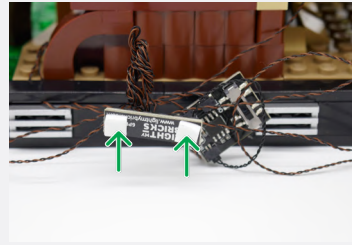

2x Adhesive Squares

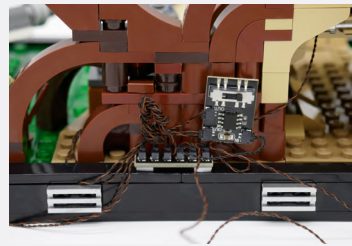
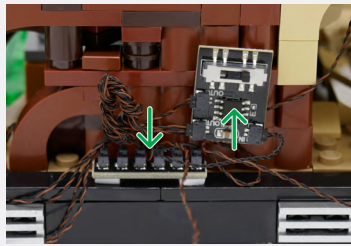
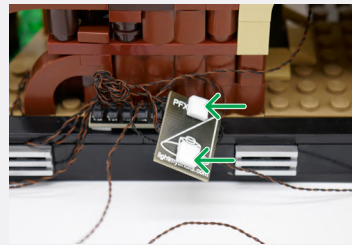

18

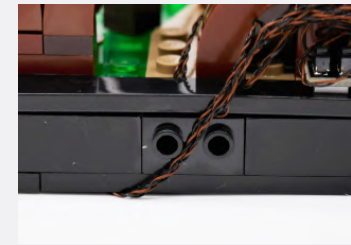
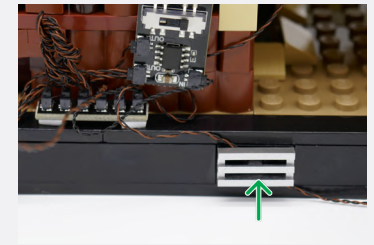
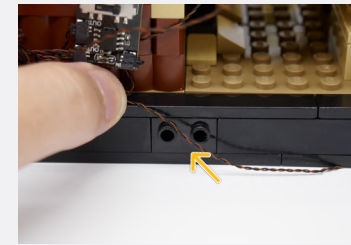
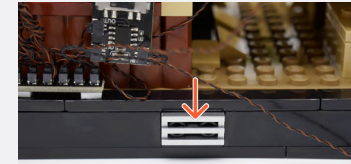

Legend



If you experience any issues with the lights not working and suspect an issue with a component, please try a different port on the expansion board to verify where the fault lies (with the light or expansion board). To correct any issues with expansion board ports, please view the section addressing expansion board issues in our troubleshooting section.

Connect the other end to a 5V USB Power Bank, 5V USB Wall Adaptor, or USB to AA Battery Pack (sold separately)



Legend

- DISCONNECT
- CONNECT / RECONNECT
- TURN / FLIP
- DIRECTIONAL
- TWIST / BRAID
- POWER ON TEST
- NOTE ICON

FINAL PRODUCT

This finally completes installation of the Light My Bricks LEGO Dagobah Jedi Training Diorama 75330 Light Kit.

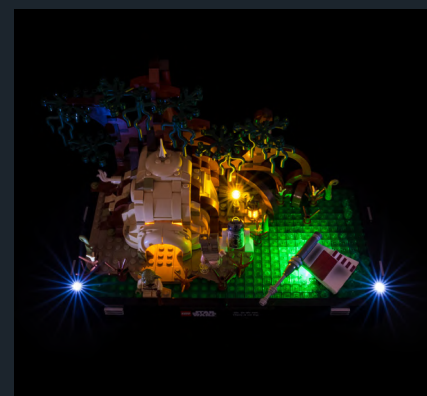
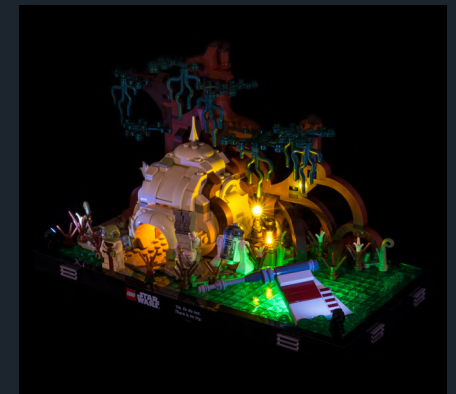
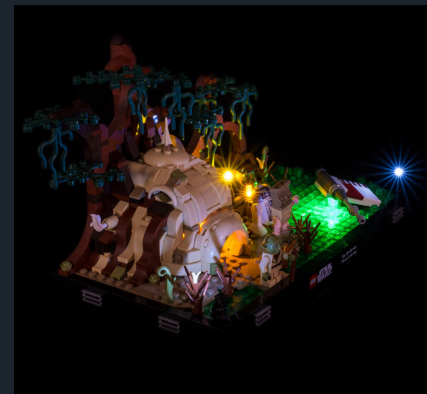
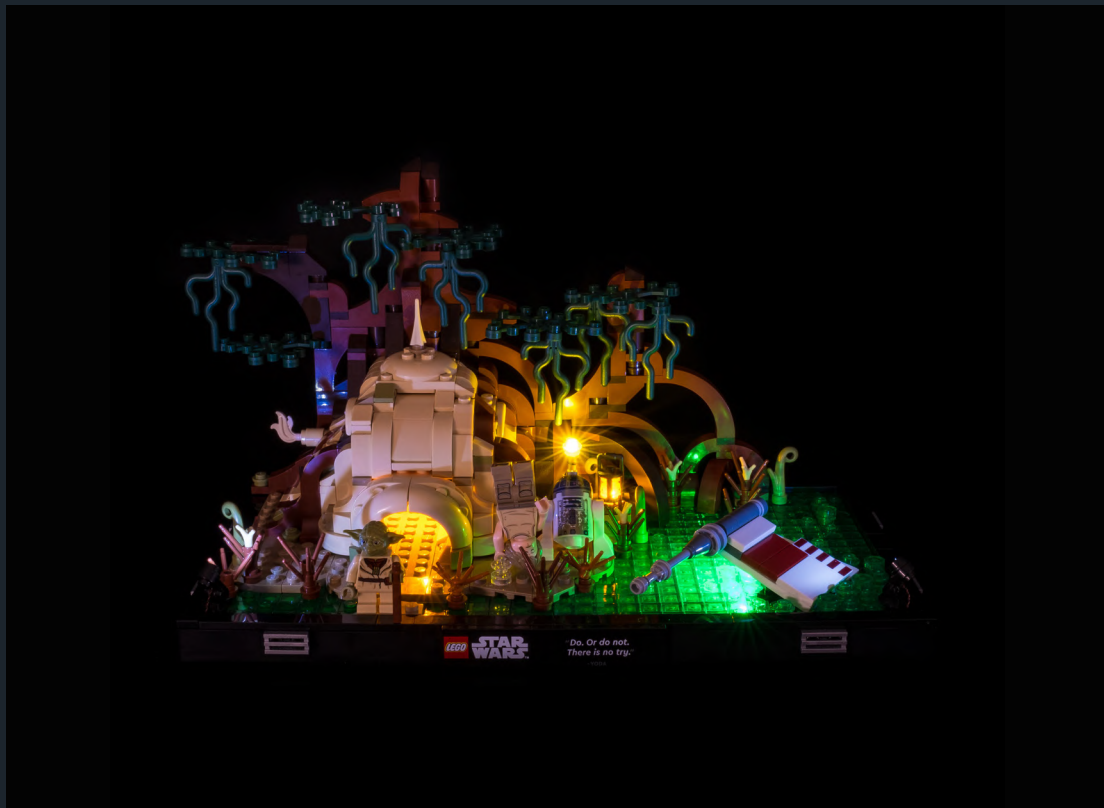



TROUBLESHOOTING

Light My Bricks lighting kits contain individual components that are very small and can be easily damaged if not handled correctly.

To prevent unnecessary damage to components, we highly recommend that the User Guide section, **“Important things to note”** is read carefully. Follow the handling procedures in the User Guide to help prevent faults and damages to your Light My Bricks components.

If you are experiencing issues with your Light My Bricks set, watch our troubleshooting video or read on for a list of common causes to help you troubleshoot.

Troubleshooting

Firstly, ensure that the batteries have power using a battery charge gauge.

If the batteries have no power, replace the batteries.

If the batteries still have power, check to see if the batteries have been inserted correctly into the battery pack.

Check For CR2032 Batteries Using The Flat Battery Pack

Inside the battery pack is a symbol indicating which side the (round) CR2032 battery should be inserted. Check that the “+” side of the battery pack has the battery with the “+” symbol facing downwards.

On the opposite side, the “-” side of the battery pack should have the battery flipped upside down, that is the “+” symbol facing upwards.

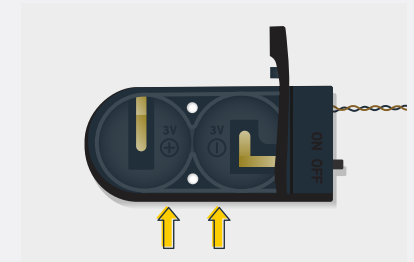

Troubleshooting

Check For Cr2032 Batteries Using The Round Battery Pack

Inside the battery pack is a symbol indicating which side the (round) CR2032 battery should be inserted. In this case, for the stacked battery pack, ensure that BOTH batteries have the “+” symbol facing upwards.

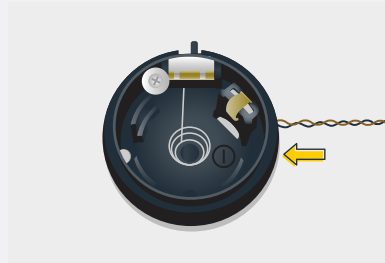

Check for AA batteries using the AA battery pack

Inside the battery pack are symbols indicating which direction the AA battery should be inserted. The flat side of the battery should be paired with the spring side of the battery pack.

If the batteries have been installed correctly and your kit still isn't operating correctly, the next step is to check the wiring.

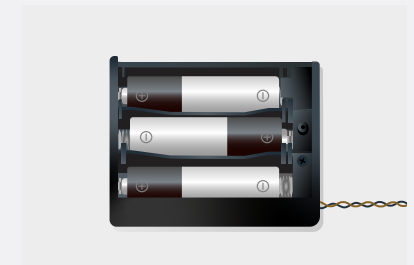
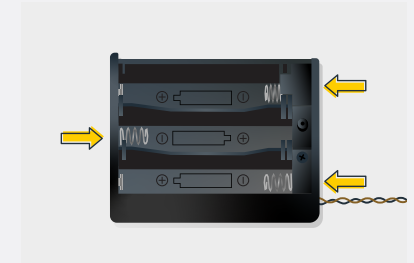

Troubleshooting

Check Your Wires

In order for Light My Bricks components to fit in between and underneath LEGO® bricks, the components need to be very small. Due to this nature, Light My Bricks components can be easily damaged when not handled correctly.

Be careful when removing unpacked components out of the packaging and ensure not to forcibly pull at the wires as this can damage the soldering that attach the wires to the LEDs.

If the wiring is detached from the LED itself, the light will not operate.

When connecting lights to your LEGO set, check that there are no pinched wires underneath or in between bricks and plates. When the wires are pinched and the exposed wires are touching each other, this can cause a crosswire and the lights to not function correctly.

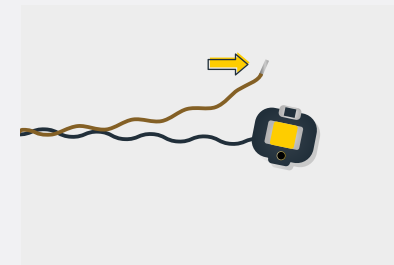
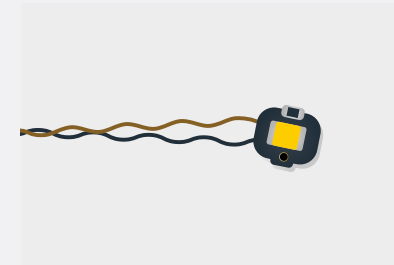

Troubleshooting

Check Your Expansion Board Ports/ Strip Light Ports / Effects Board Ports

It is important to note that connectors can only be inserted to the expansion board, strip light, or effects board ports in one direction.

Forcibly inserting connectors in the incorrect direction will result in damaging the pins inside each of the ports on your component board.

Not only will a light connected to the damaged port not work, but if the pins inside the port are bent to a point they are touching each other, this can result in all other lights in the system to stop working. This is a short circuit.

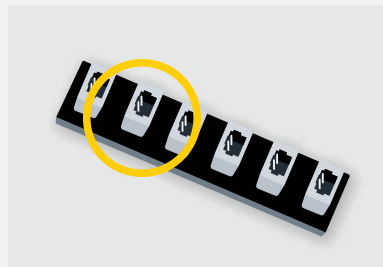

A short circuit can also result in overheating of the board, cable or batteries. If you suspect a short circuit, **DISCONNECT POWER IMMEDIATELY**. Batteries can fail, catch fire, or even explode if left connected to a short circuit for too long.

If you suspect you have a faulty component due to a bent pin, try the following steps:

If you look carefully inside each of the ports, each port contains 2 small pins that should be straight. You will be able to identify a faulty port if it has any bent pins.

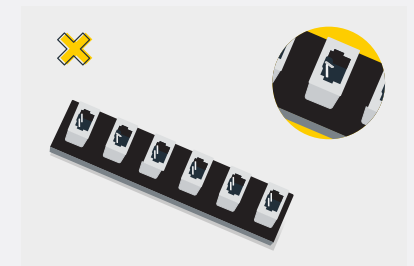
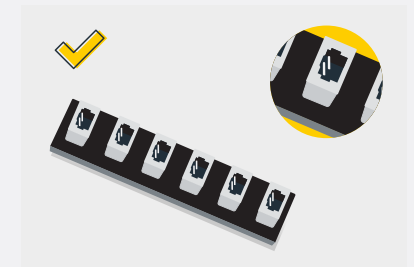
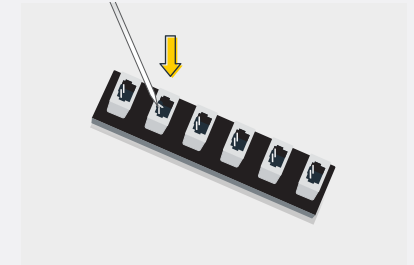



CONTACT US

If you have an enquiry regarding the online shop, our products or a general enquiry please refer to our Frequently Asked Questions webpage.

Alternatively, you can contact our Customer Services team by visiting our online support portal.

support.lightmybricks.com

We thank you for purchasing this product and hope you enjoy!



lightmybricks.com