



**LIGHT^{MY}
BRICKS**



**LEGO® MEDIEVAL CASTLE
#31120 LIGHT KIT
INSTALLATION GUIDE**

Light My Bricks



LEGO® MEDIEVAL CASTLE #31120 LIGHT KIT INSTALLATION GUIDE

Hi There!

We're here to help you get started on the LEGO®
Medieval Castle (31120) Light Kit.

This PDF details the instructions for the LED light kit only.

If you run into any issues, please refer to the
troubleshoot-ing section towards the end of this guide.

Have fun and enjoy!

INSTALLATION GUIDE



PACKAGE CONTENTS:



- 6 x White 15cm Bit Light
- 7 x White 30cm Bit Light *
- 2 x Cool White 15cm Bit Light
- 1 x Green 30cm Bit Light
- 7 x White 30cm Micro Bit Light *



- 4 x 6-Port Expansion Board
- 1 x 4-Port Micro Expansion Board
- 1 x 8-Port Micro Expansion Board
- 14 x Adhesive Square



- 2 x Flicker Effects Board



- 3 x 5cm Connecting Cable
- 1 x 15cm Connecting Cable
- 4 x 30cm Connecting Cable *



- 1 x USB Power Cable
(Power Source not Included)

LEGO PIECES:



- 7 x Plate 2x2 w Rounded Bottom – Trans Clear
- 2 x Slope 30 1x1x1/2 – Trans Clear
- 1 x Plate 2 x 8 – Black
- 1 x Round Plate 1x1 – White
- 2 x Round Plate 1x1 w Open Stud – Black
- 1 x Round Plate 1x1 w Open Stud – White
- 1 x Round Plate 1x1 w Open Stud – Pearl Gold
- 1 x Wave Rounded Small with Pin (Candle Flame)

* Indicates Components which include spares.

Contents

Before You Begin	5
Blueprint	8
Instructions	9
Final Product	43
Troubleshooting	44
Contact	49

Before You Begin



Laying cables in between and underneath bricks

Cables can fit in between and underneath LEGO® bricks, plates, and tiles providing they are laid correctly between the LEGO® studs. Do NOT forcefully join LEGO® together around cables; instead ensure they are laying comfortably in between each stud.

CAUTION: Forcing LEGO® to connect over a cable can result in damaging the cable and light.

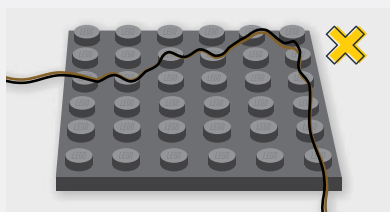

Connecting Cable Connectors To Expansion Boards

Take extra care when inserting connectors to ports of Expansion Boards. Connectors can be inserted only one way. With the expansion board facing up, look for the soldered “=” symbol on the left side of the port. The connector side with the wires exposed should be facing toward the soldered “=” symbol as you insert into the port. If a plug won’t fit easily into a port connector, do not force it.

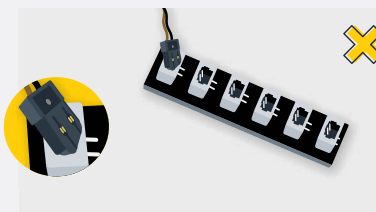

Incorrectly inserting the connector can result in bent pins inside the port or possible overheating of the expansion board when connected.

Before You Begin

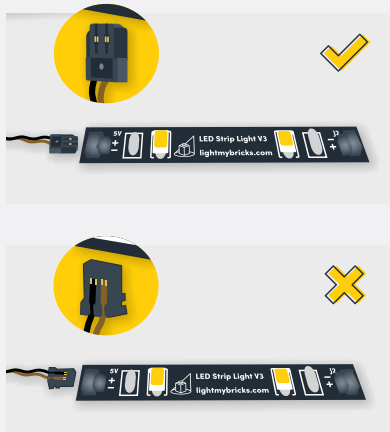

Connecting Cable Connectors To Strip Lights

Take extra care when inserting connectors to ports on the Strip Lights. Connectors can be inserted only one way. With the Strip Light facing up, ensure the side of the connector with the wires exposed is facing down. If a plug won't fit easily into a port connector, don't force it. Doing so will damage the plug and the connector.



Connecting Micro Cable Connectors To Micro Expansion Board Ports

Take extra care when inserting the micro connectors to micro ports of Micro Expansion Boards. Connecting Micro Bit Lights to Micro Expansion Boards is similar to connecting lights and cables to Strip Lights. With the expansion board facing up, ensure the side of the connector with the wires exposed is facing down. If a plug won't fit easily into a port connector, do not force it. Use your fingernail to push the plastic part of the connector to the micro port.

Before You Begin

Installing Bit Lights Under Lego® Bricks And Plates

When installing Bit Lights under LEGO® pieces, ensure they are placed the correct way up (Yellow LED component exposed). You can either place them directly on top of LEGO® studs or in between.



BLUEPRINT

Steps 1-6

Steps 7-12

Steps 13-30

Steps 30-39

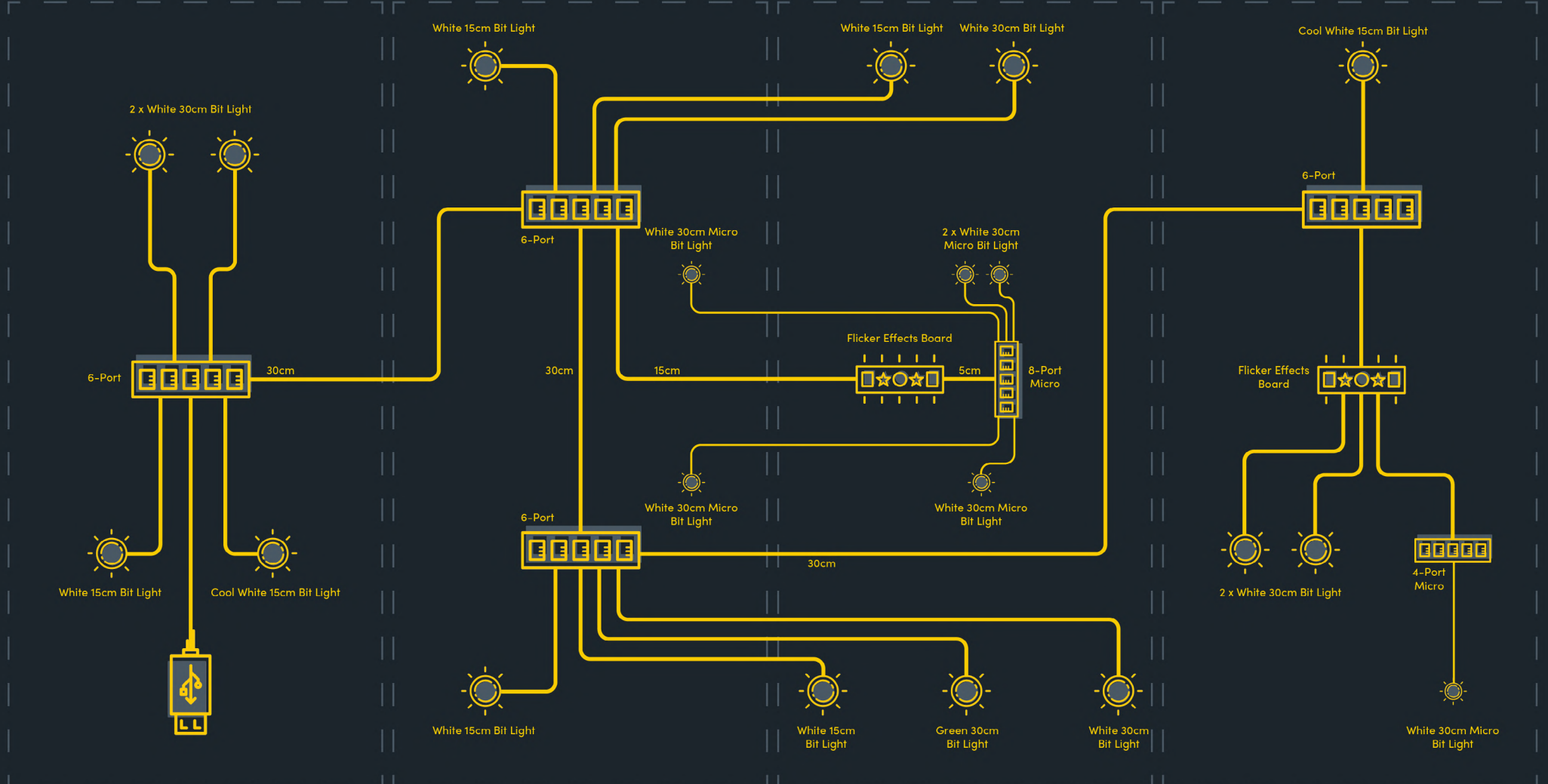



INSTRUCTIONS

To ensure a smooth installation of your light kit, please read and follow each step carefully. If you run into any issues, please refer to the online troubleshooting guide.

	LEGEND:		DISCONNECT		CONNECT / RECONNECT		TURN / FLIP		DIRECTIONAL		TWIST / BRAID		POWER ON / TEST
	LEGENDE:		TRENNEN		VERNINDEN / WIEDERVERBINDEN		WENDEN / KIPPEN		DIRECTIONAL		DREHEN / VERDREHEN		EINSCHALTEN / TESTEN
	LÉGENDE:		DÉCONNECTER		CONNECTER / RECONNECTER		TOUR / INCLINAISON		DIRECTIONNEL		TORSION / TRESSER		POWER ON / TEST
	LEGGENDA:		SCOLLEGARE		CONNETTI / RICONNETTI		ROTARE / INCLINARE		DIREZIONALE		TWIST / TRECCIA		POWER ON / TEST

1



2

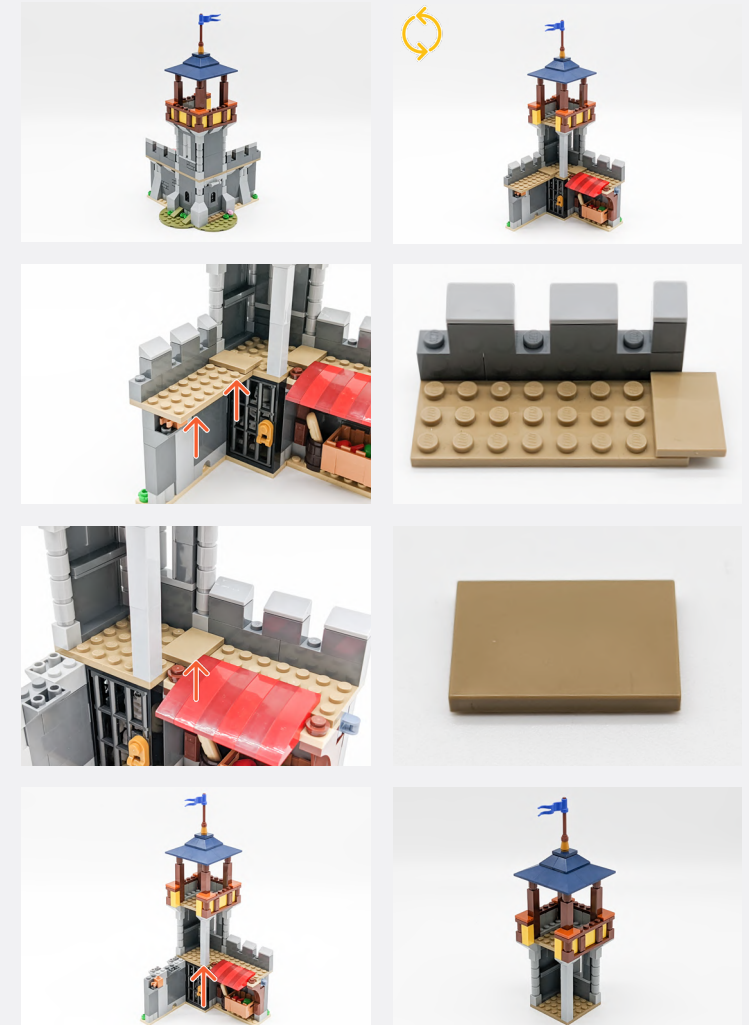

Legend

- DISCONNECT
- CONNECT / RECONNECT
- ↻ TURN / FLIP
- DIRECTIONAL
- ↻↻ TWIST / BRAID
- ✳ POWER ON TEST
- 📝 NOTE ICON

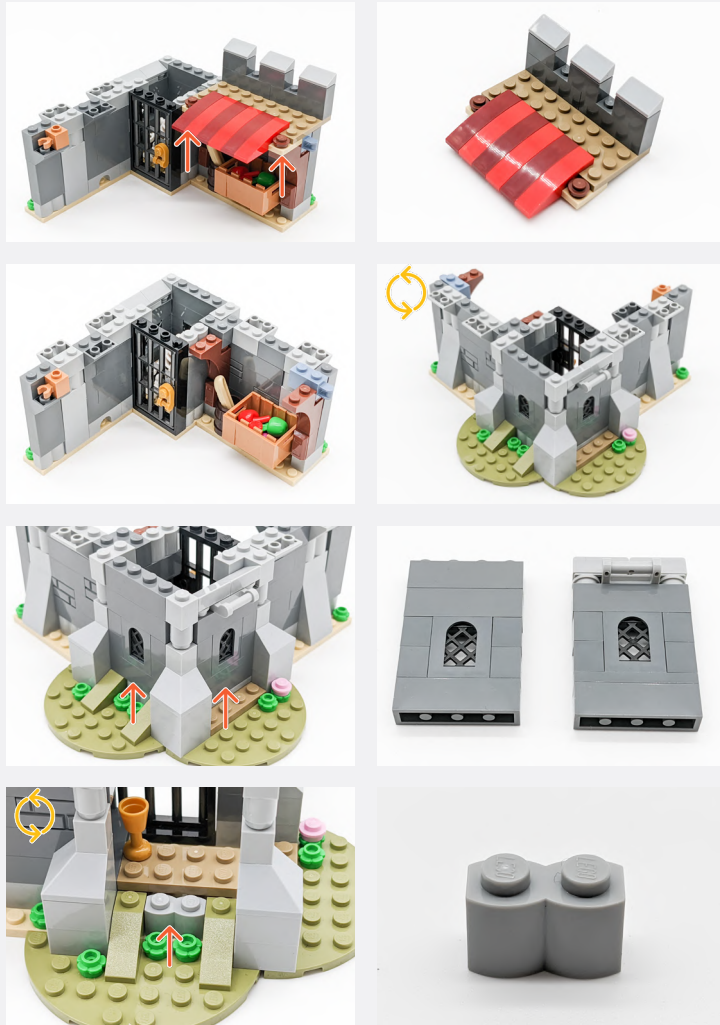

3

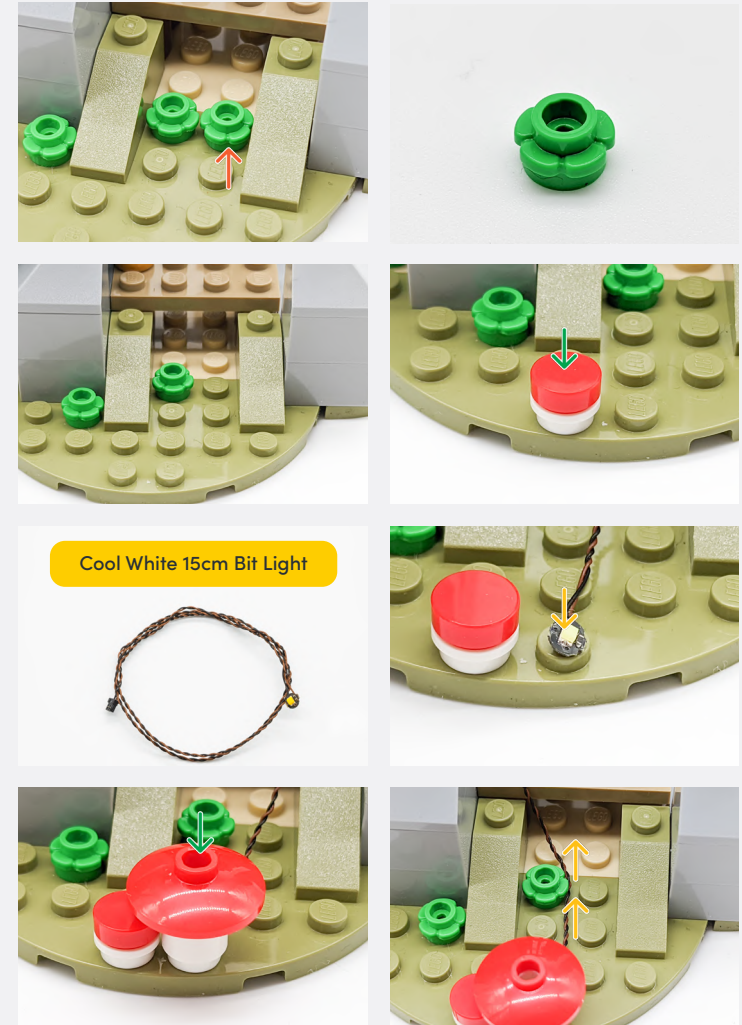

Legend → DISCONNECT → CONNECT / RECONNECT ↻ TURN / FLIP → DIRECTIONAL ↻ TWIST / BRAID ✨ POWER ON TEST 📝 NOTE ICON

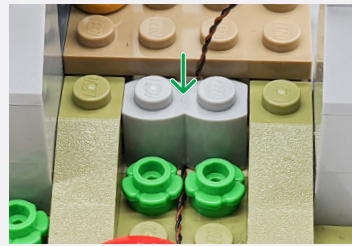
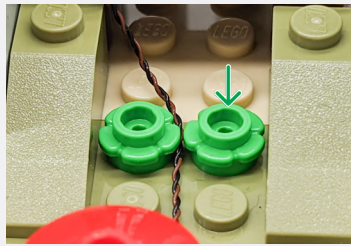

6-Port Expansion Board

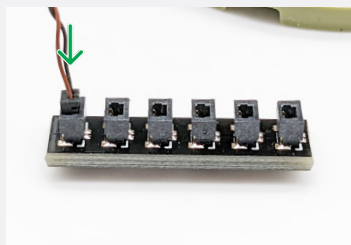

30cm Connecting Cable

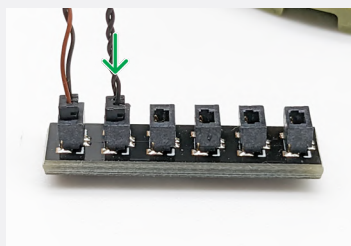

4

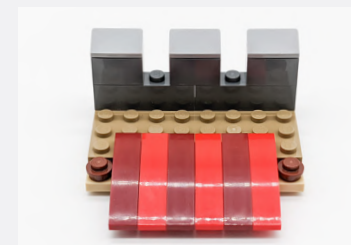

White 15cm Bit Light



Trans Clear Round Plate 2x2 w/ Rounded Bottom

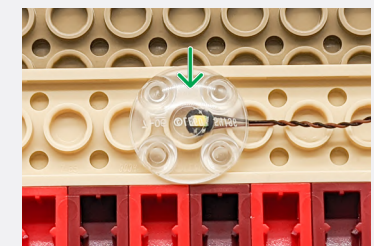
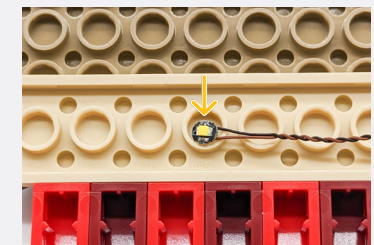
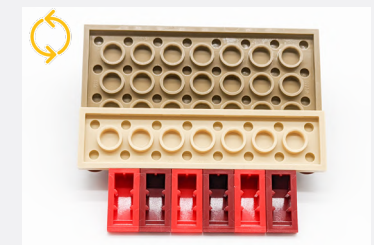

Legend → DISCONNECT → CONNECT / RECONNECT ↻ TURN / FLIP → DIRECTIONAL ↻ TWIST / BRAID ✨ POWER ON TEST 📝 NOTE ICON

📌 If you experience any issues with the lights not working and suspect an issue with a component, please try a different port on the expansion board to verify where the fault lies (with the light or expansion board). To correct any issues with expansion board ports, please view the section addressing expansion board issues in our troubleshooting section.

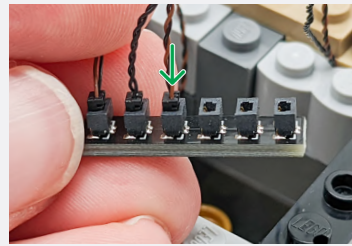

📌 Connect the other end to a USB Power Bank, USB Wall Adaptor, or USB to AA Battery Pack (sold separately)

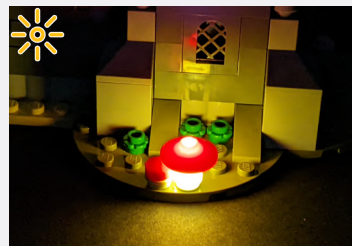
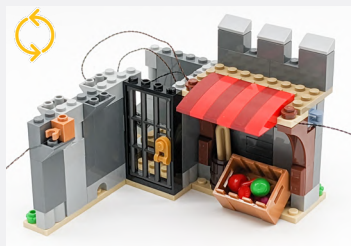

5

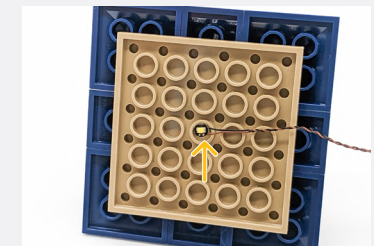
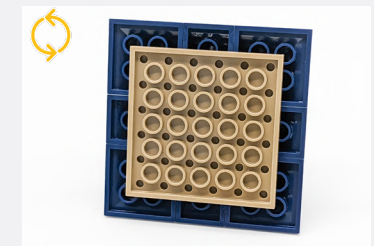

Legend → DISCONNECT → CONNECT / RECONNECT ↻ TURN / FLIP → DIRECTIONAL ↻ TWIST / BRAID ✨ POWER ON TEST 📌 NOTE ICON

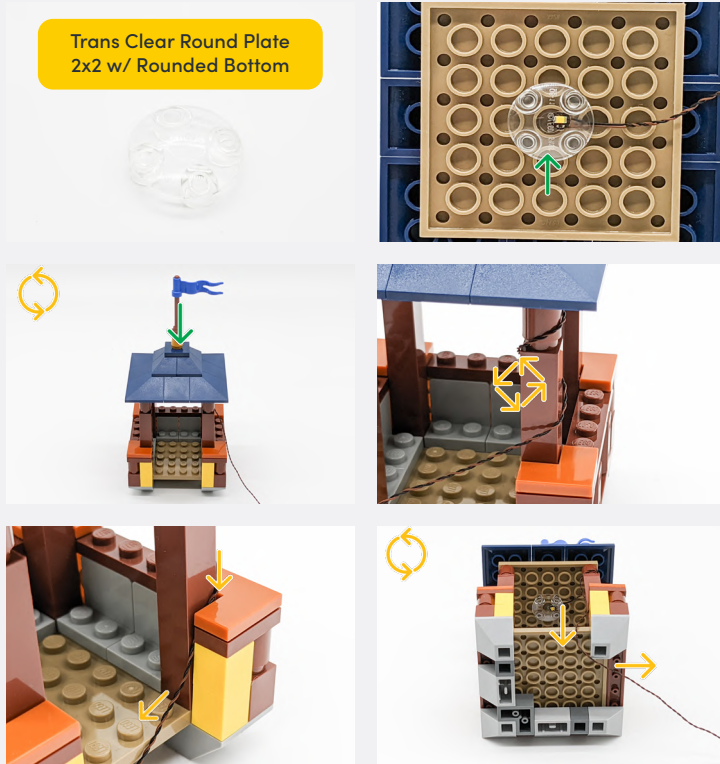

6

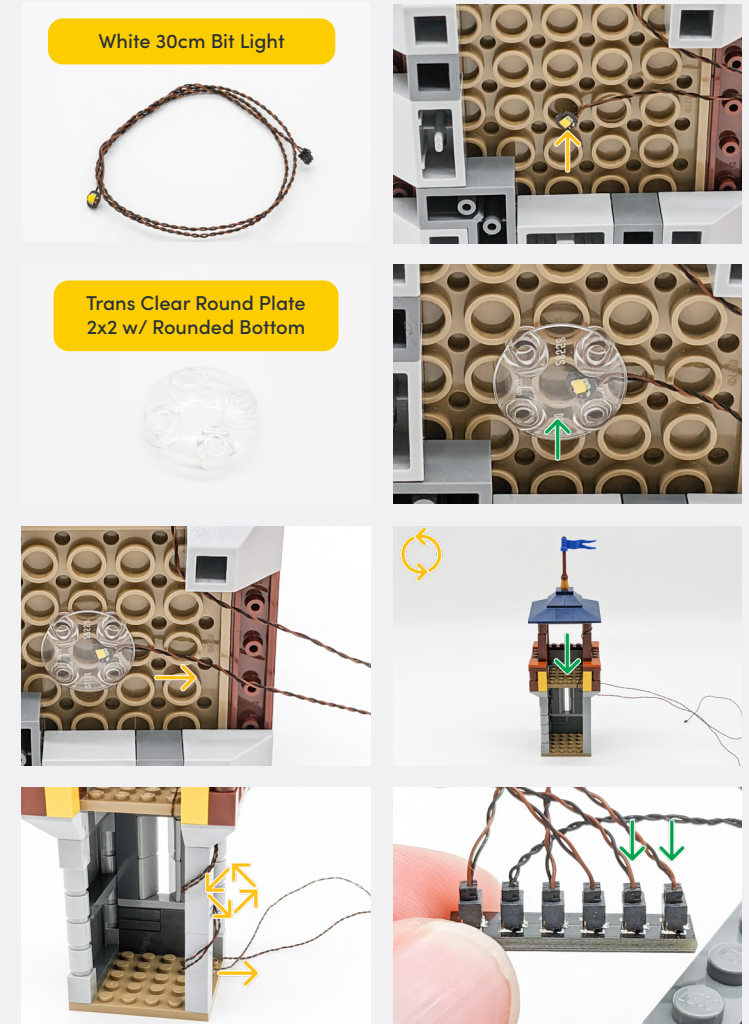

Legend

- DISCONNECT
- CONNECT / RECONNECT
- ↻ TURN / FLIP
- DIRECTIONAL
- ↻↻ TWIST / BRAID
- ✳ POWER ON TEST
- 📝 NOTE ICON

☑ If you experience any issues with the lights not working and suspect an issue with a component, please try a different port on the expansion board to verify where the fault lies (with the light or expansion board). To correct any issues with expansion board ports, please view the section addressing expansion board issues in our troubleshooting section.

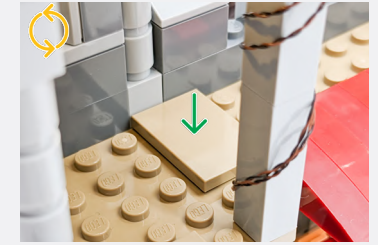
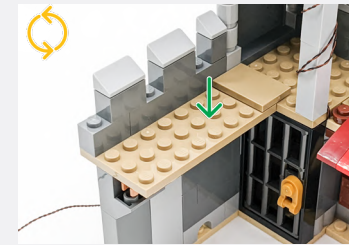
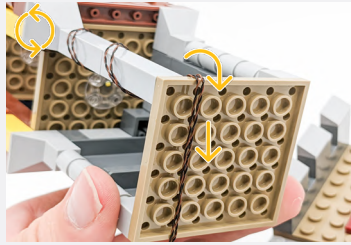

☑ Exclude the USB Power Cable when twisting.

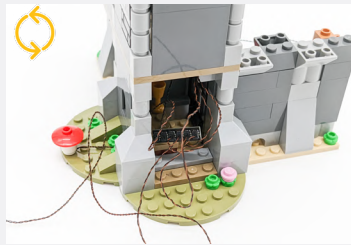

2x Adhesive Squares



7

☑ Ensure to leave the USB Power Cable running under the wall when connecting.

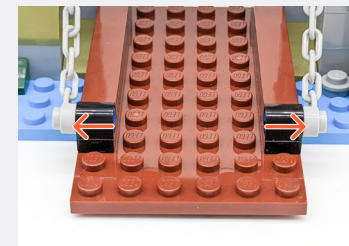

Legend → DISCONNECT → CONNECT / RECONNECT ↻ TURN / FLIP → DIRECTIONAL ↻ TWIST / BRAID ✨ POWER ON TEST 📝 NOTE ICON



8



Legend → DISCONNECT → CONNECT / RECONNECT ↻ TURN / FLIP → DIRECTIONAL ↻ TWIST / BRAID ✨ POWER ON TEST 📝 NOTE ICON

9



10

White 15cm Bit Light

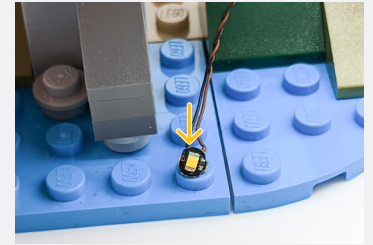

Slope 30 1 x 1 x 2/3 Trans Clear

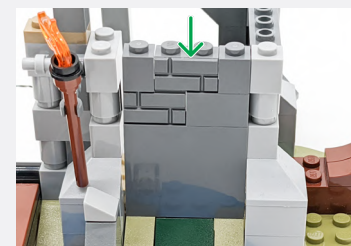
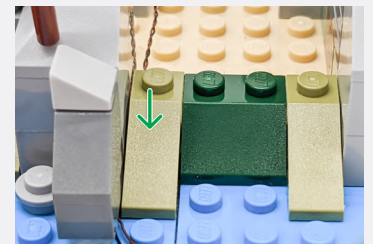
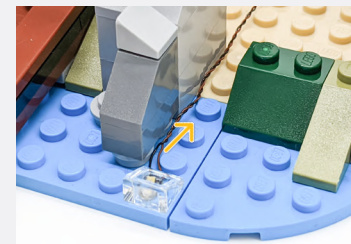
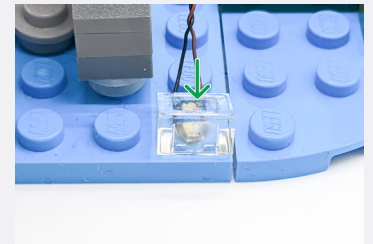

Legend

- DISCONNECT
- CONNECT / RECONNECT
- TURN / FLIP
- DIRECTIONAL
- TWIST / BRAID
- POWER ON TEST
- NOTE ICON

11

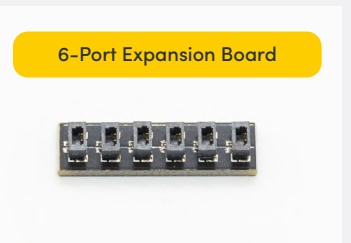
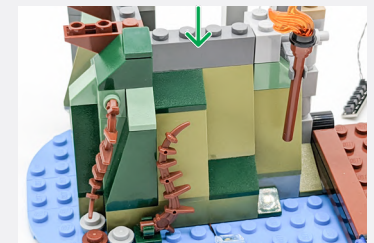
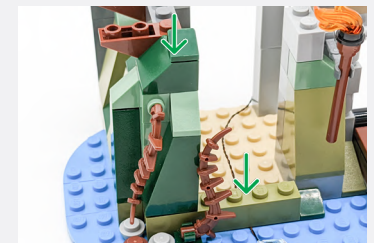
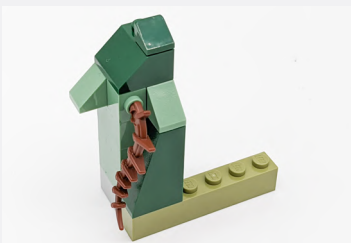
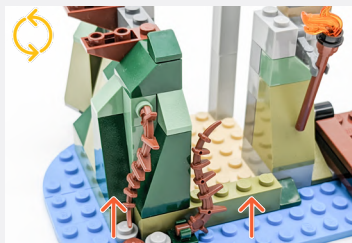
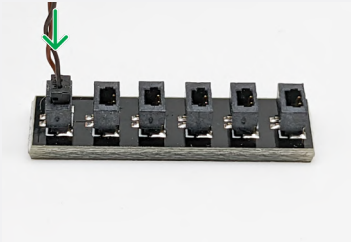

Legend

- DISCONNECT
- CONNECT / RECONNECT
- ↻ TURN / FLIP
- DIRECTIONAL
- ↻↻ TWIST / BRAID
- ✳ POWER ON TEST
- 📝 NOTE ICON

📌 If you experience any issues with the lights not working and suspect an issue with a component, please try a different port on the expansion board to verify where the fault lies (with the light or expansion board). To correct any issues with expansion board ports, please view the section addressing expansion board issues in our troubleshooting section.

📌 Connect the other end of the 30cm Connecting Cable to the 6-Port Expansion Board on the other side of the gate.

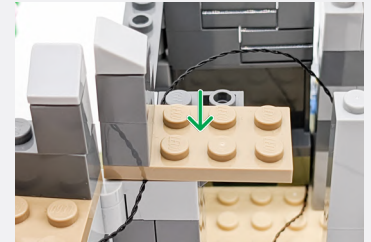
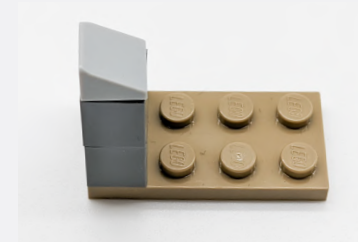
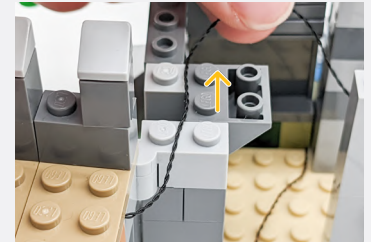
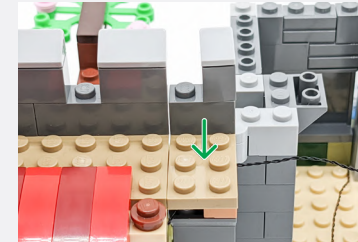
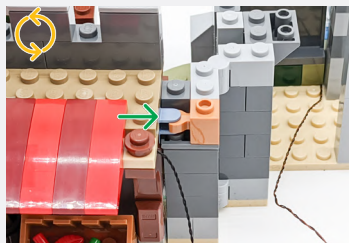
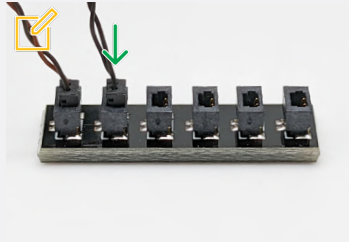
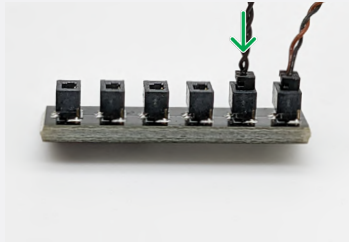
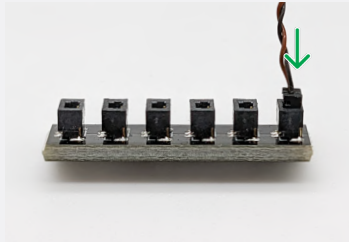

📌 Connect the other end of the 30cm Connecting Cable from the watchtower section to the 6-Port Expansion Board on the left side of the gate.

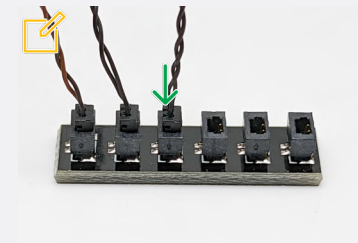

Legend → DISCONNECT → CONNECT / RECONNECT ↻ TURN / FLIP → DIRECTIONAL ↺ TWIST / BRAID ✨ POWER ON TEST 📌 NOTE ICON

12

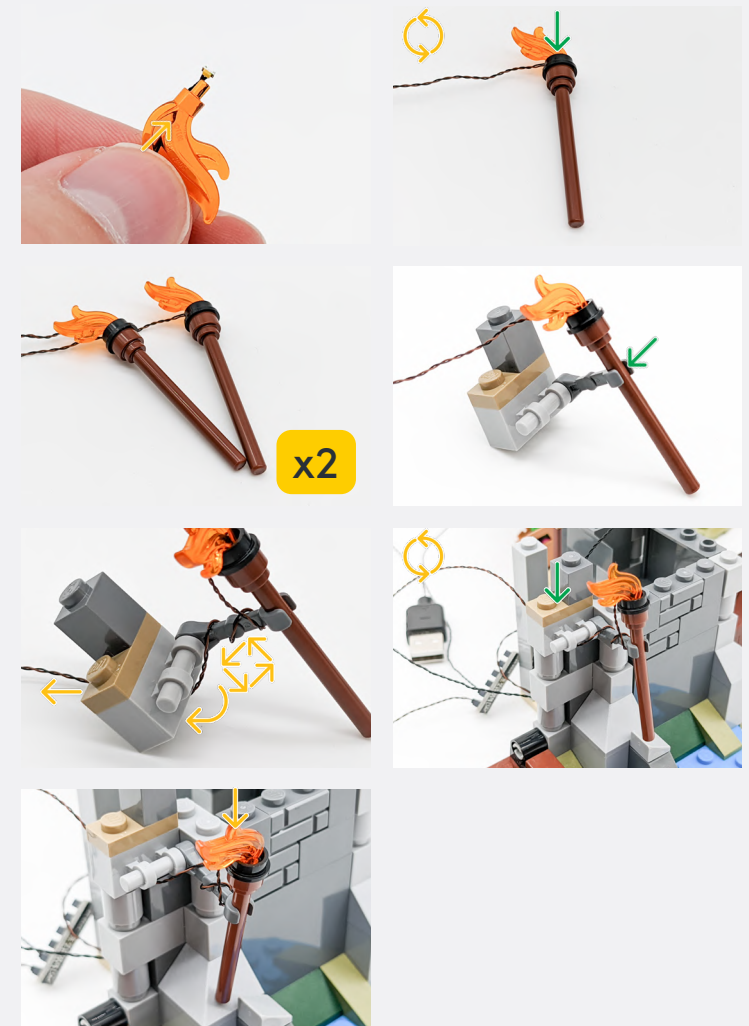

Legend

- DISCONNECT
- CONNECT / RECONNECT
- ↻ TURN / FLIP
- DIRECTIONAL
- ↻↻ TWIST / BRAID
- ✳ POWER ON TEST
- 📝 NOTE ICON

13

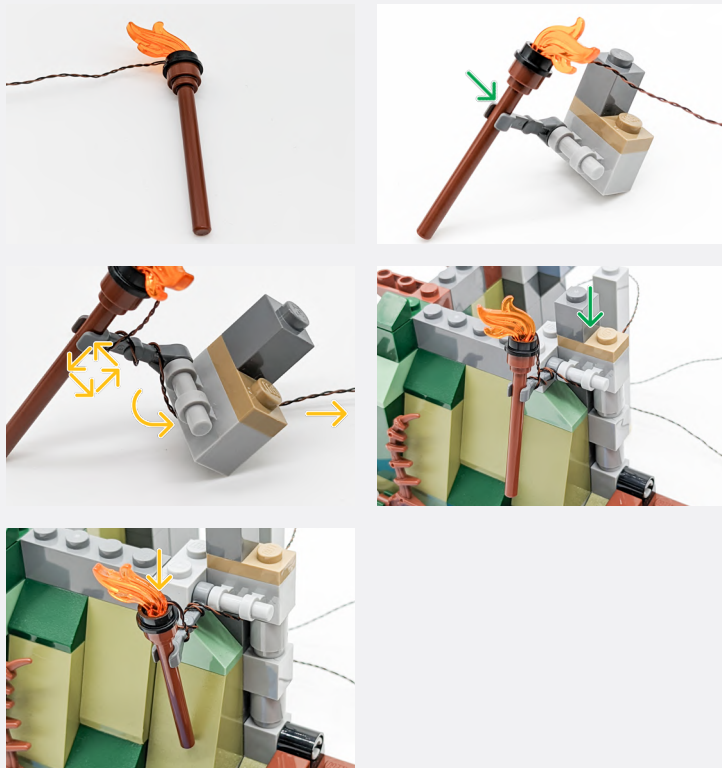

14

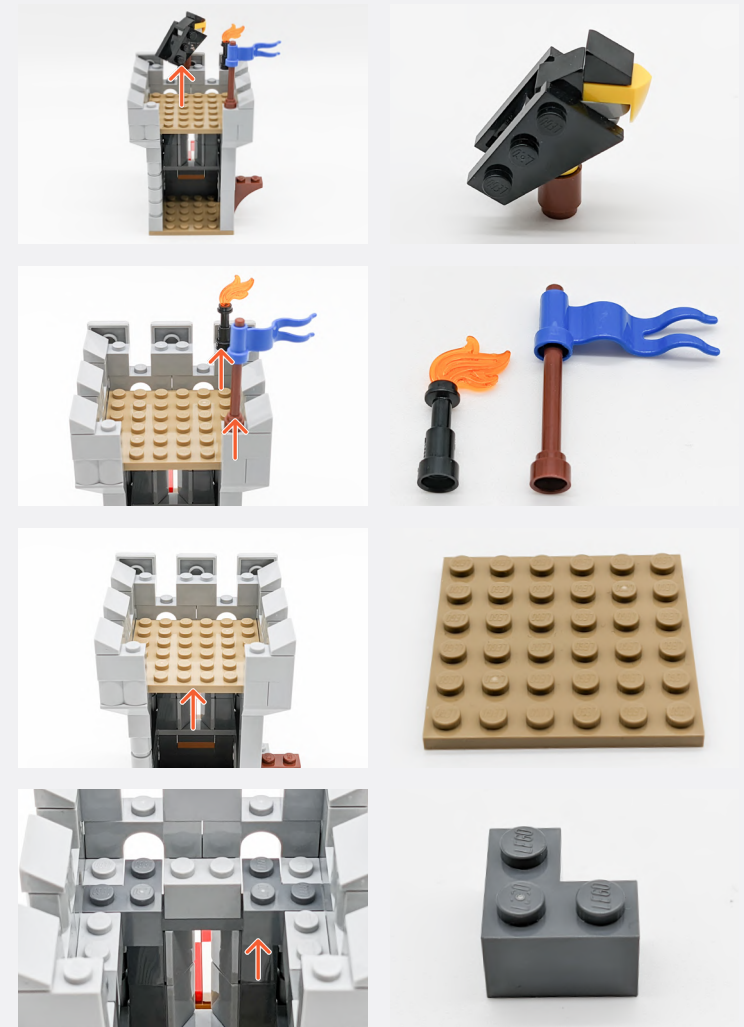

Legend

- DISCONNECT
- CONNECT / RECONNECT
- ↻ TURN / FLIP
- DIRECTIONAL
- ↻↻ TWIST / BRAID
- ✳ POWER ON TEST
- 📝 NOTE ICON

15

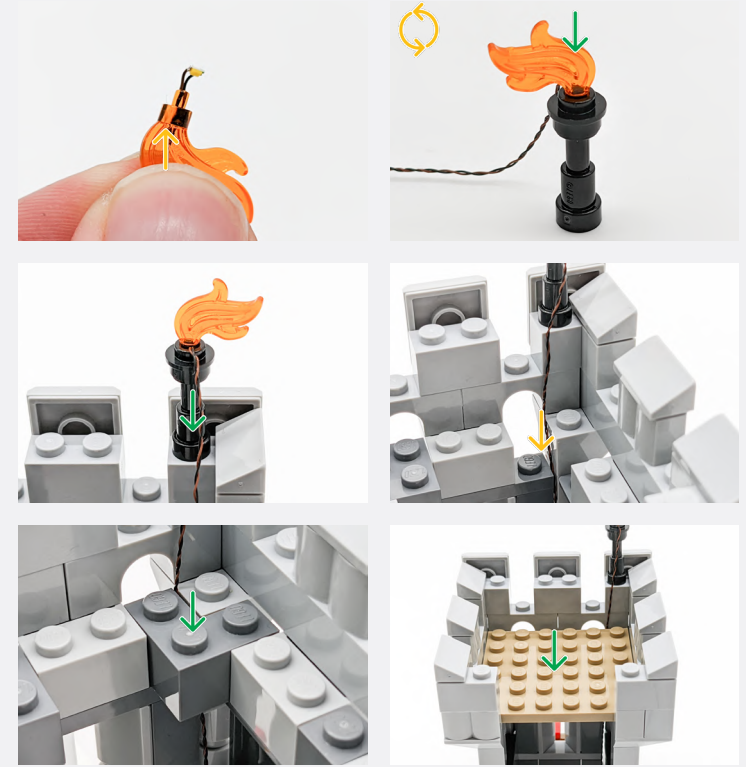

Legend

- DISCONNECT
- CONNECT / RECONNECT
- TURN / FLIP
- DIRECTIONAL
- TWIST / BRAID
- POWER ON TEST
- NOTE ICON

16

Round Plate 1x1 W Open Stud - Pearl Gold



Round Plate 1x1 W Open Stud - White



White 30cm Micro Bit Light



Wave Rounded Small W Pin (Candle Flame)

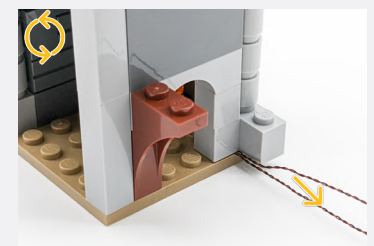
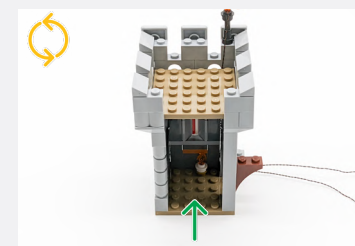
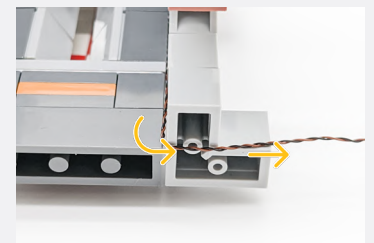
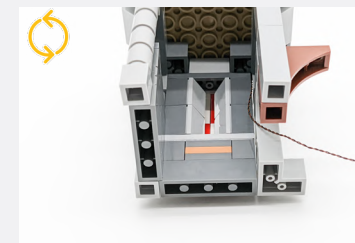
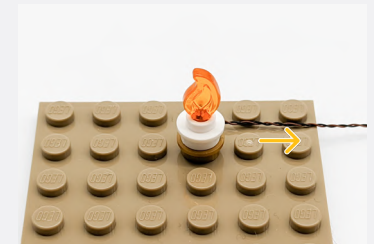
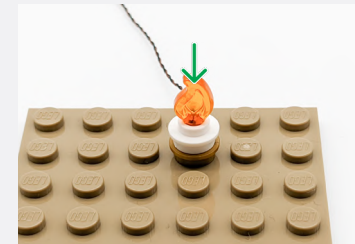
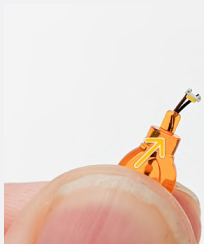

Legend

- DISCONNECT
- CONNECT / RECONNECT
- TURN / FLIP
- DIRECTIONAL
- TWIST / BRAID
- POWER ON TEST
- NOTE ICON

17

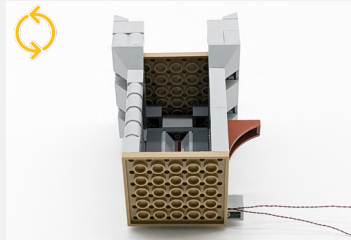

White 30cm Bit Light

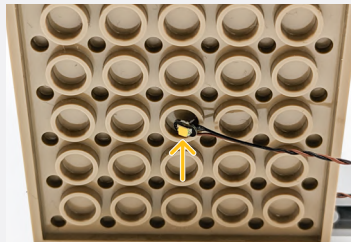

Trans Clear Round Plate 2x2 w/ Rounded Bottom

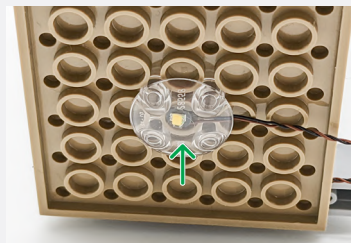

18

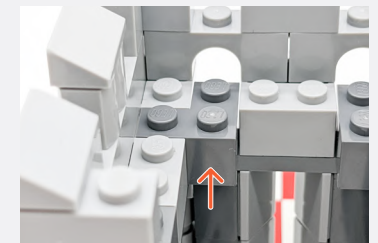
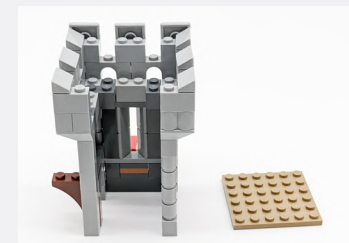
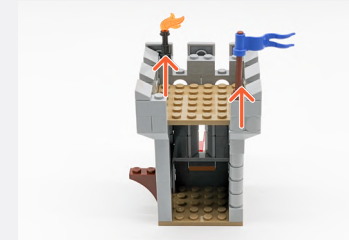

Legend

- DISCONNECT
- CONNECT / RECONNECT
- TURN / FLIP
- DIRECTIONAL
- TWIST / BRAID
- POWER ON TEST
- NOTE ICON

19



Black Round Plate 1x1 w/ Open Stud



White 30cm Micro Bit Light



20

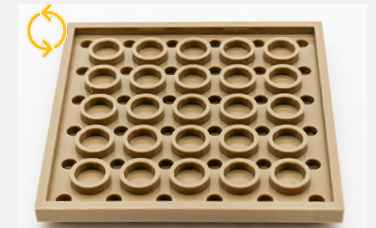
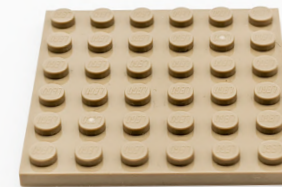
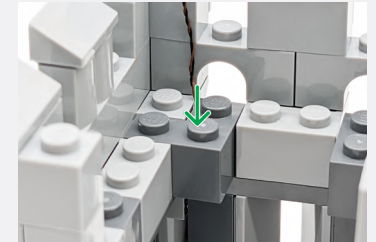
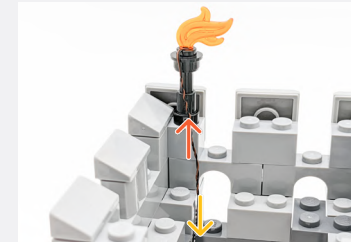

White 30cm Bit Light

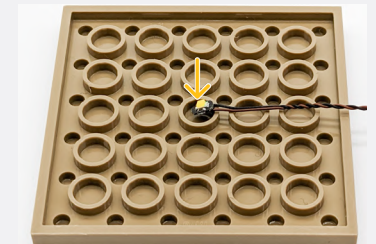

Trans Clear Round Plate 2x2 w/ Rounded Bottom

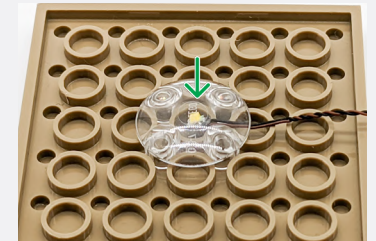

Legend

- DISCONNECT
- CONNECT / RECONNECT
- TURN / FLIP
- DIRECTIONAL
- TWIST / BRAID
- POWER ON TEST
- NOTE ICON

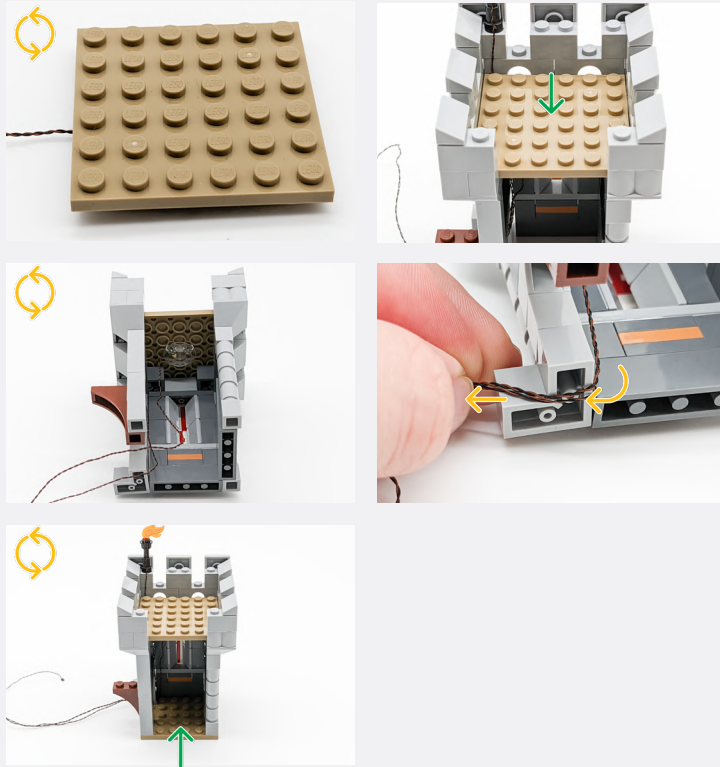

21

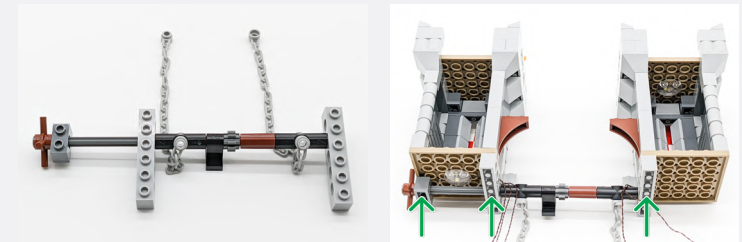

Connect the three Micro Bit Light cables to the Micro 8-Port Expansion Board, excluding the regular Bit Light cables.

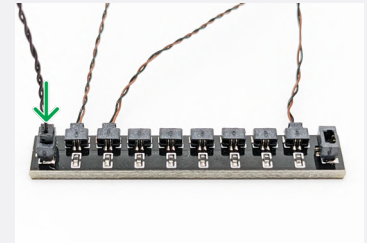
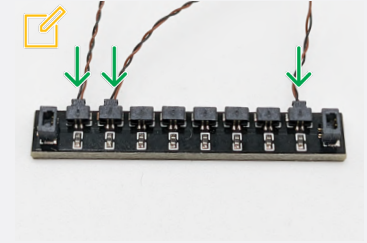

Legend DISCONNECT CONNECT / RECONNECT TURN / FLIP DIRECTIONAL TWIST / BRAID POWER ON TEST NOTE ICON

Flicker Effects Board

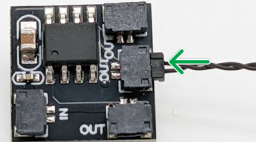

15cm Connecting Cable

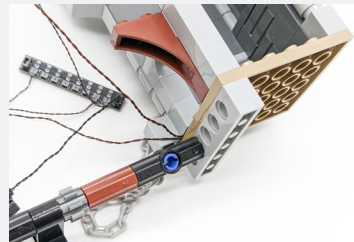
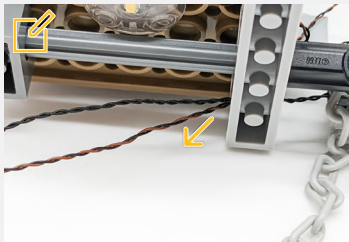
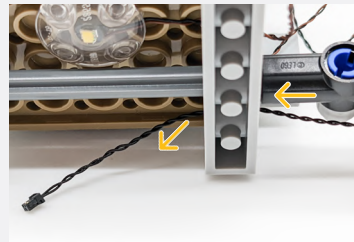
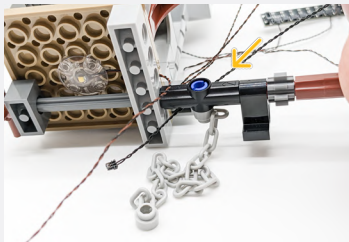
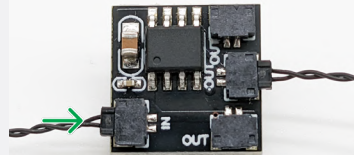

📌 Thread the other Bit Light cable from this tower through the hole.

22

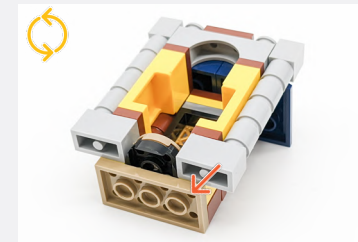
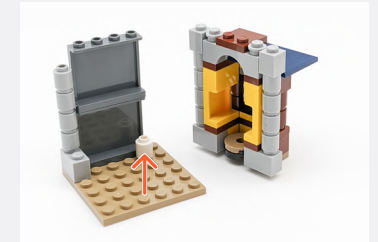
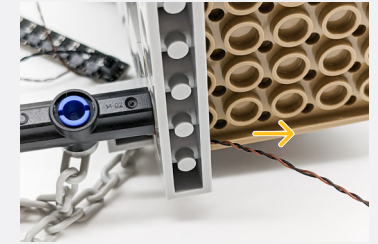

Legend

- DISCONNECT
- CONNECT / RECONNECT
- ↻ TURN / FLIP
- DIRECTIONAL
- ↻↻ TWIST / BRAID
- ✳ POWER ON TEST
- 📌 NOTE ICON

23

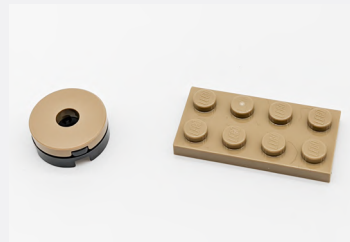

Green 30cm Bit Light

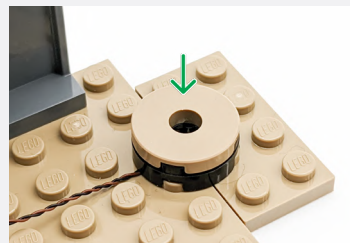
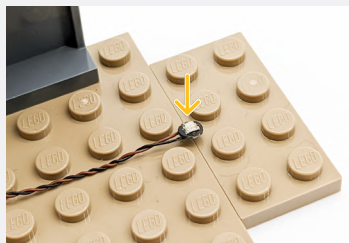

24

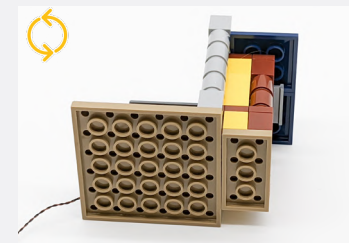
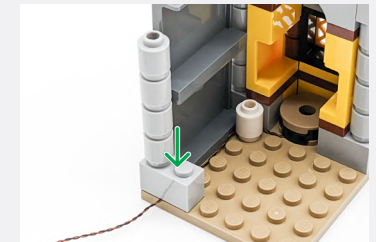
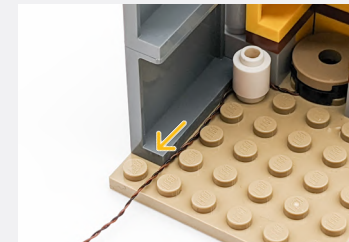
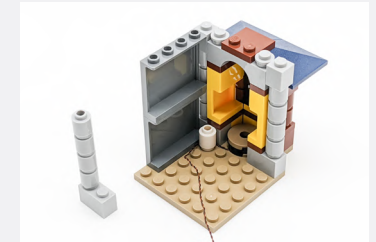
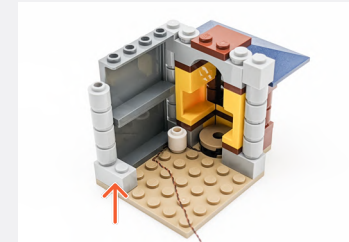

White 15cm Bit Light

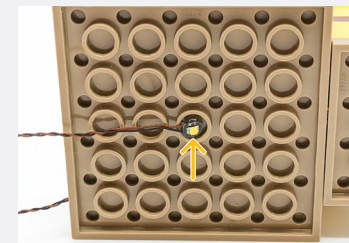

Trans Clear Round Plate 2x2 w/ Rounded Bottom



Legend

- DISCONNECT
- CONNECT / RECONNECT
- TURN / FLIP
- DIRECTIONAL
- TWIST / BRAID
- POWER ON TEST
- NOTE ICON

25

	<p>White 15cm Bit Light</p>
	<p>Trans Clear Round Plate 2x2 w/ Rounded Bottom</p>

26

Legend

- DISCONNECT
- CONNECT / RECONNECT
- TURN / FLIP
- DIRECTIONAL
- TWIST / BRAID
- POWER ON TEST
- NOTE ICON



27

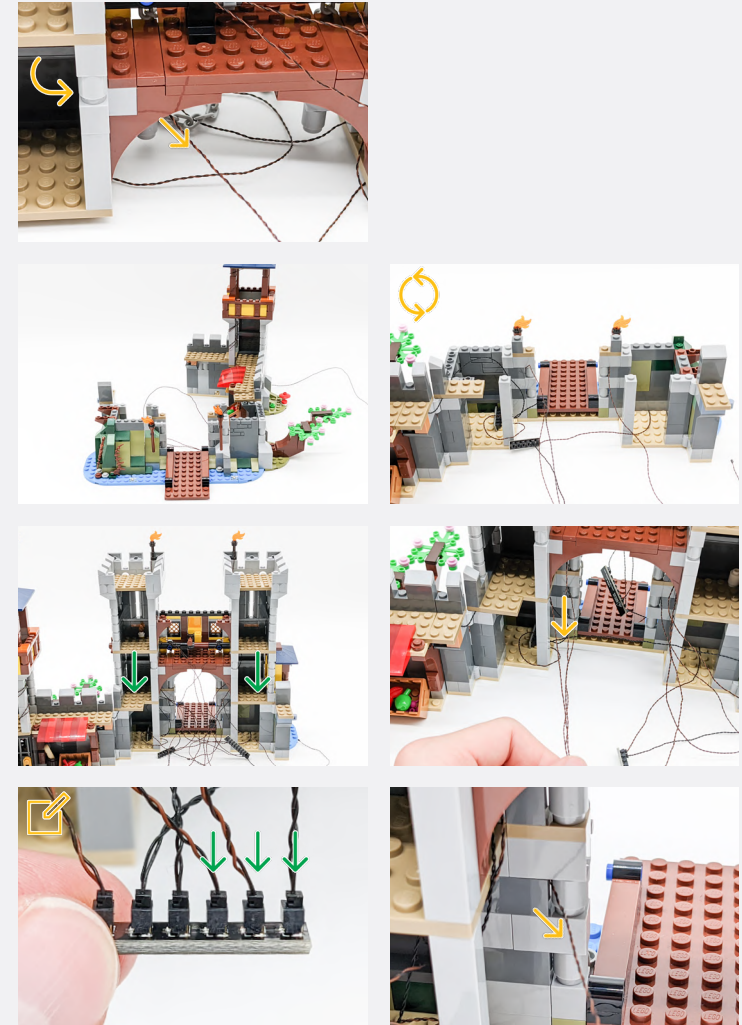

📌 Connect all the cables from the LEFT tower into the LEFT 6-Port Expansion Board, excluding the Micro Bit Light cables from the lower torch.

Legend → DISCONNECT → CONNECT / RECONNECT ↻ TURN / FLIP → DIRECTIONAL ↺ TWIST / BRAID ✨ POWER ON TEST 📌 NOTE ICON

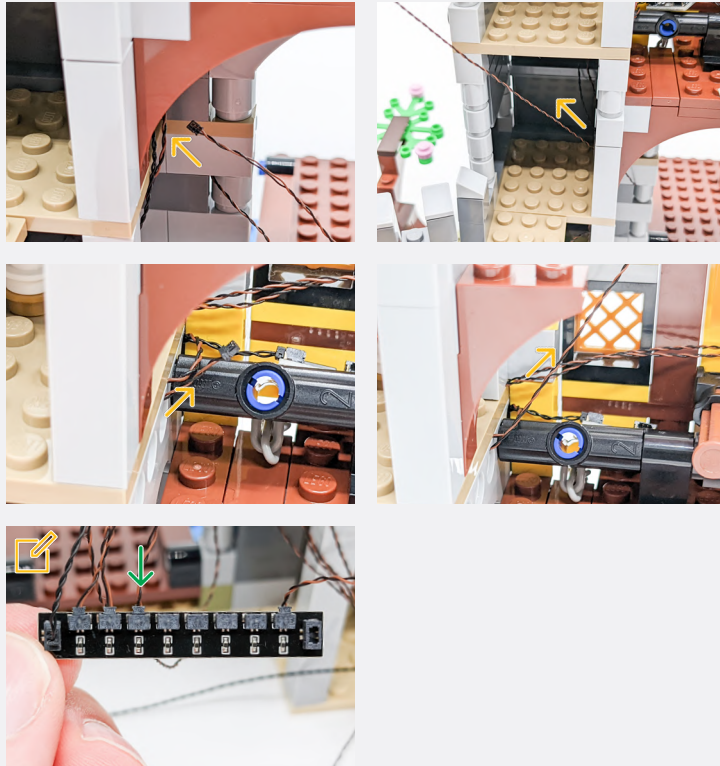

✍️ Connect the Micro Bit Light cable from the lower torch on the left tower into the Micro 8-Port Expansion Board.

28

✍️ Connect all the cables from the RIGHT tower into the RIGHT 6-Port Expansion Board, excluding the Micro Bit Light cables from the lower torch.

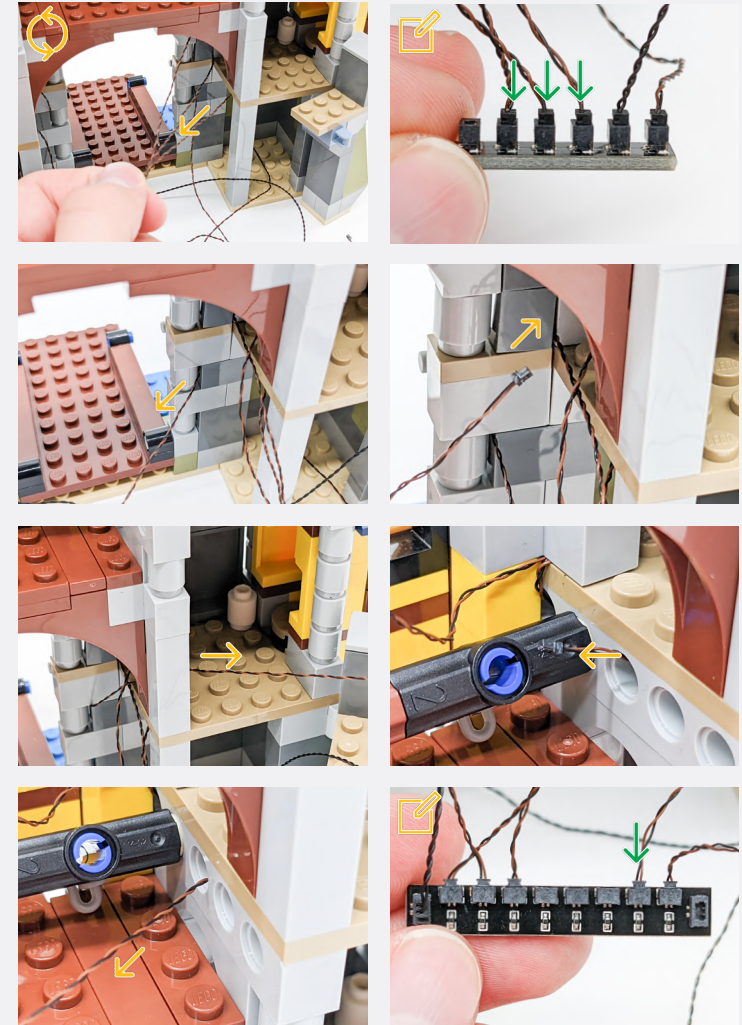

✍️ Connect the Micro Bit Light cable from the lower torch on the right tower into the Micro 8-Port Expansion Board.

Legend → DISCONNECT → CONNECT / RECONNECT ↻ TURN / FLIP → DIRECTIONAL ↻ TWIST / BRAID ✨ POWER ON TEST ✍️ NOTE ICON

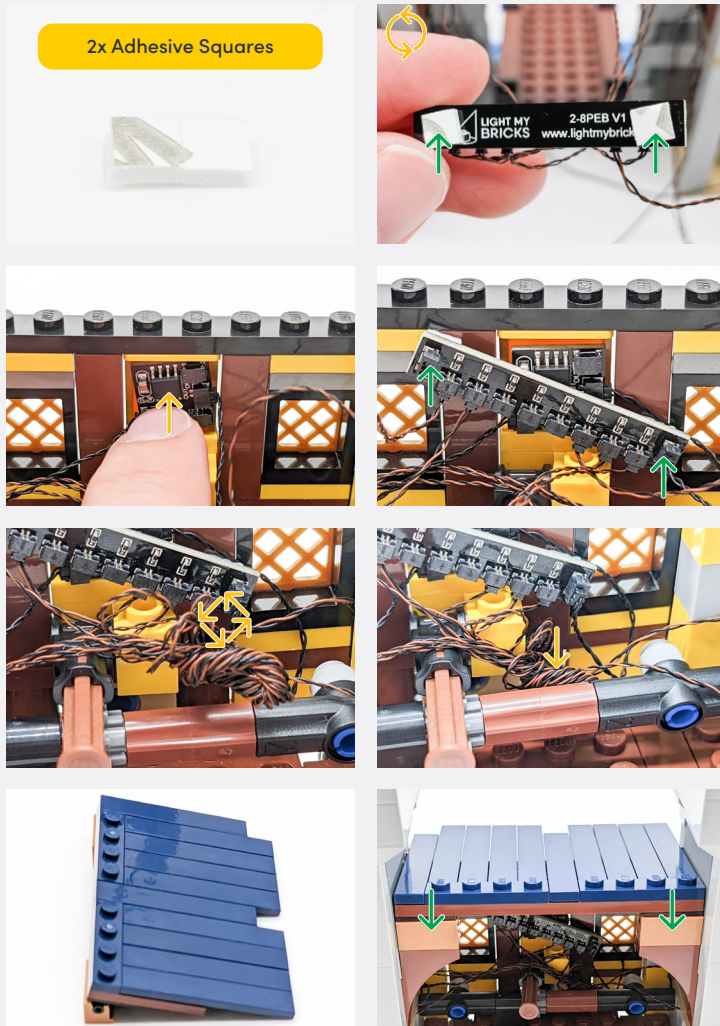

29

Adhere the LEFT 6-Port Expansion Board to the underside of the LEFT tower bottom floor.

When twisting the cables, exclude the 30cm Connecting Cable running to the other side of the gate.

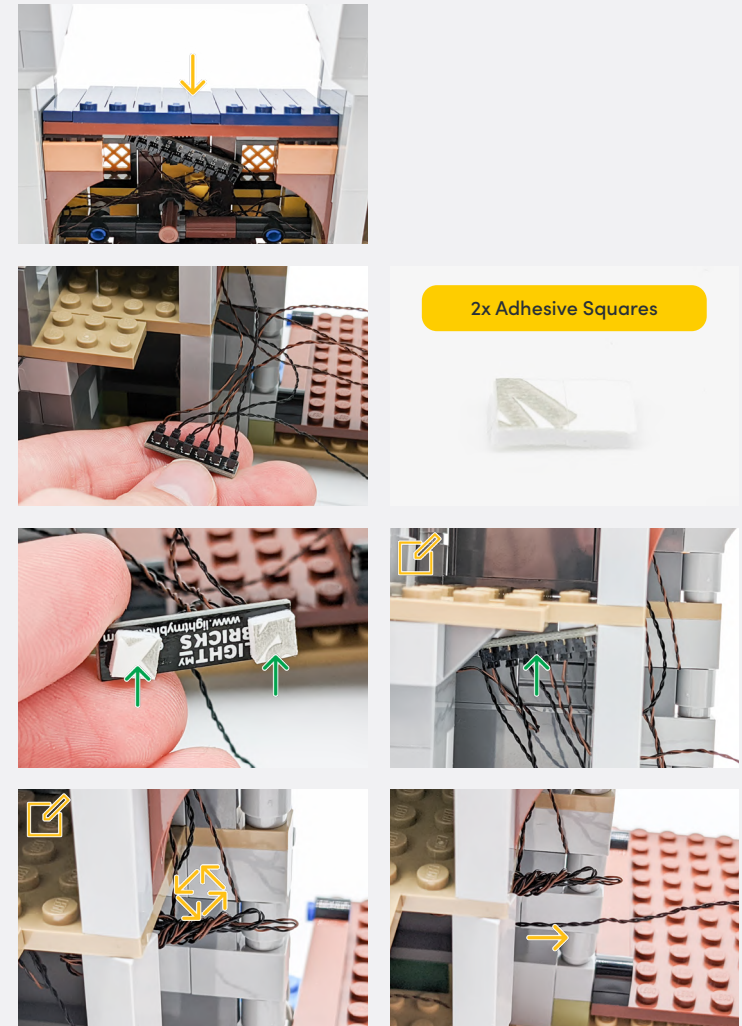

Legend DISCONNECT CONNECT / RECONNECT TURN / FLIP DIRECTIONAL TWIST / BRAID POWER ON TEST NOTE ICON

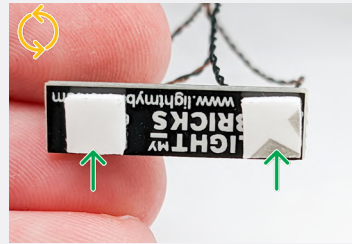
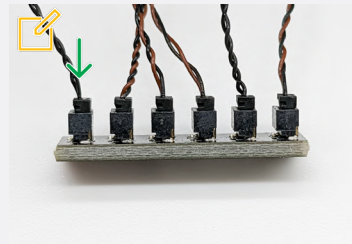
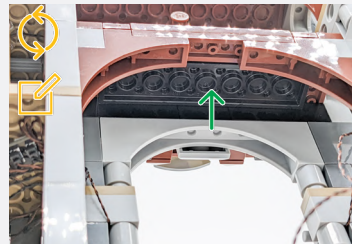
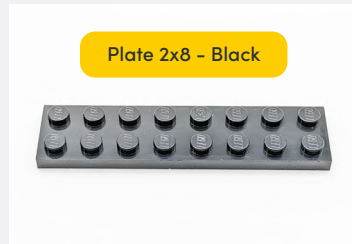
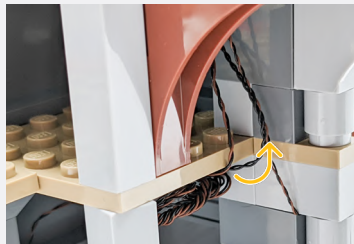

Connect the Plate to the underside of the gate, securing the 30cm Connecting Cable.

30

Connect the 30cm Connecting Cable to the RIGHT 6-Port Expansion Board.

When twisting the cables, exclude the 30cm Connecting Cable from this step.

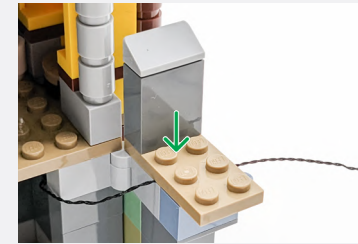
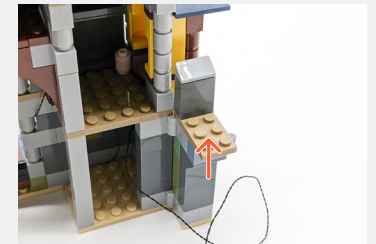
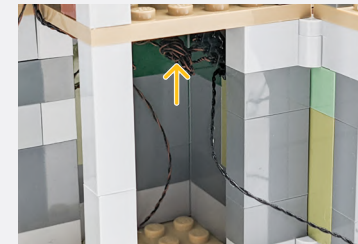
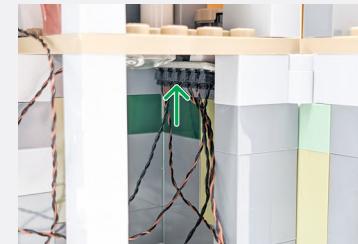

Legend → DISCONNECT → CONNECT / RECONNECT ↻ TURN / FLIP → DIRECTIONAL ↻ TWIST / BRAID * POWER ON TEST 📝 NOTE ICON

📌 If you experience any issues with the lights not working and suspect an issue with a component, please try a different port on the expansion board to verify where the fault lies (with the light or expansion board). To correct any issues with expansion board ports, please view the section addressing expansion board issues in our troubleshooting section.

31



32

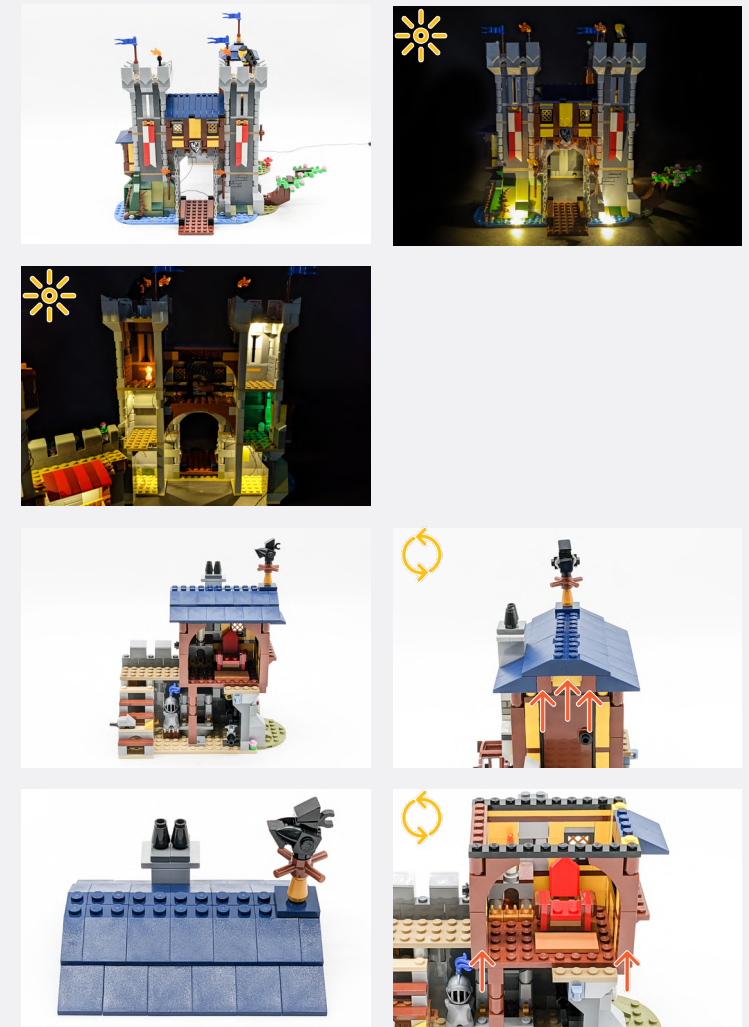

Legend

- DISCONNECT
- CONNECT / RECONNECT
- ↻ TURN / FLIP
- DIRECTIONAL
- ↻↻ TWIST / BRAID
- ☀️ POWER ON TEST
- 📌 NOTE ICON

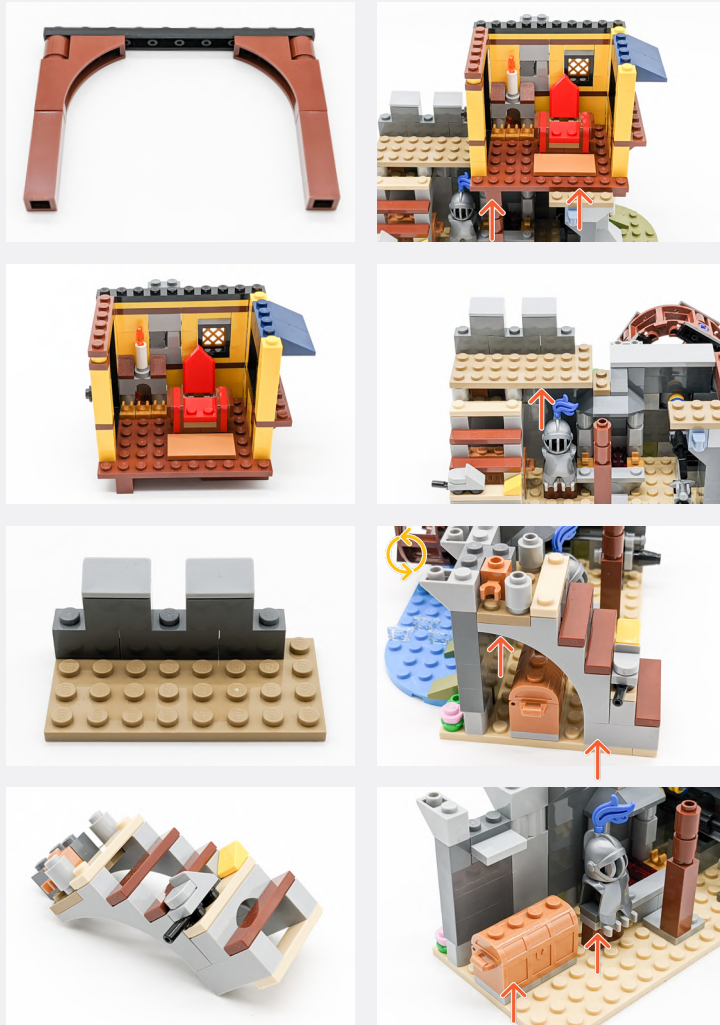

33

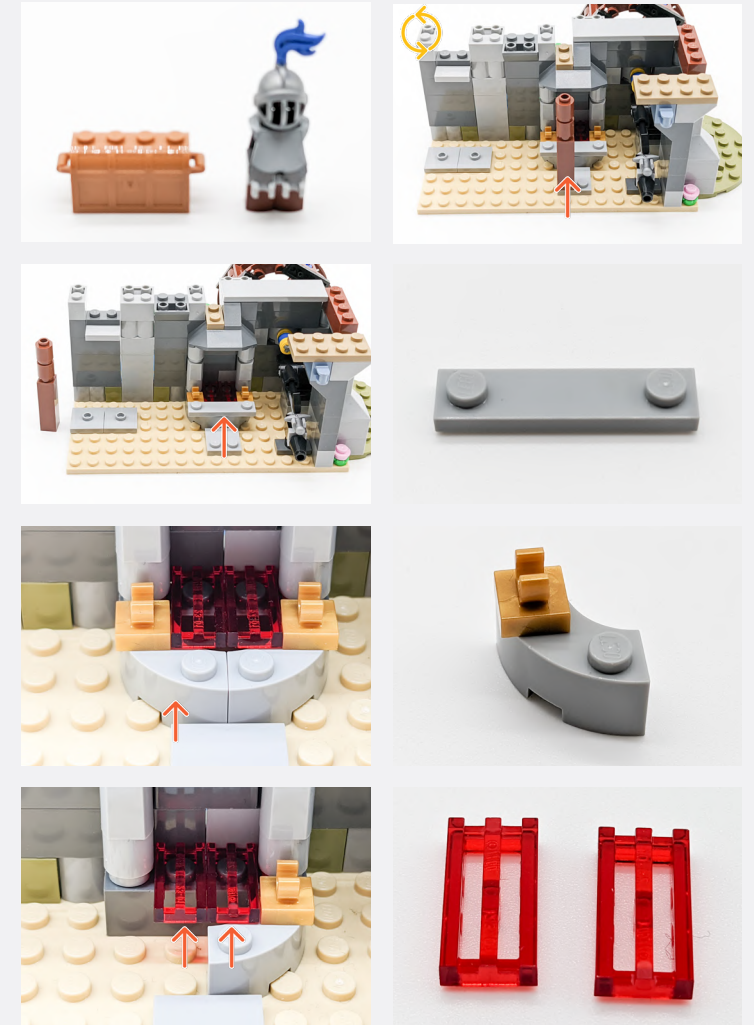

Legend → DISCONNECT → CONNECT / RECONNECT ↻ TURN / FLIP → DIRECTIONAL ↻ TWIST / BRAID * POWER ON TEST 📝 NOTE ICON



34

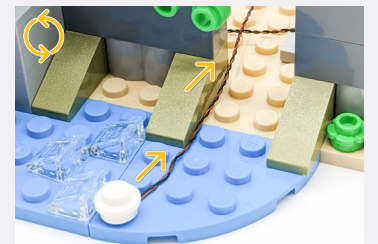
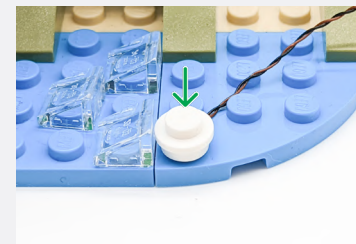
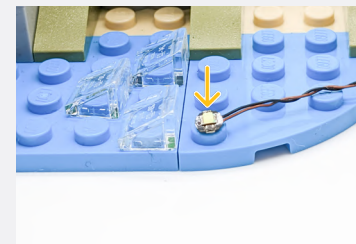
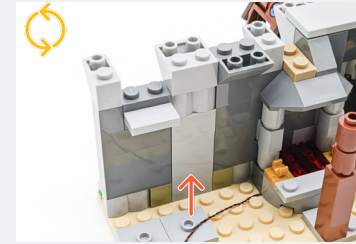

Legend → DISCONNECT → CONNECT / RECONNECT ↻ TURN / FLIP → DIRECTIONAL ↻ TWIST / BRAID * POWER ON TEST 📝 NOTE ICON

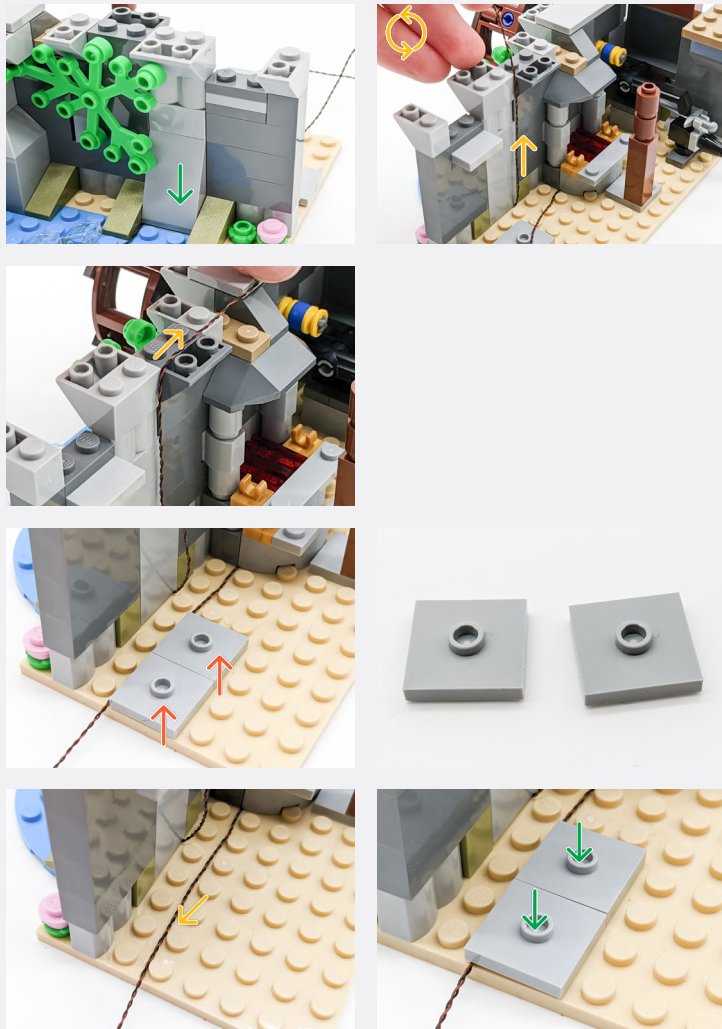

35

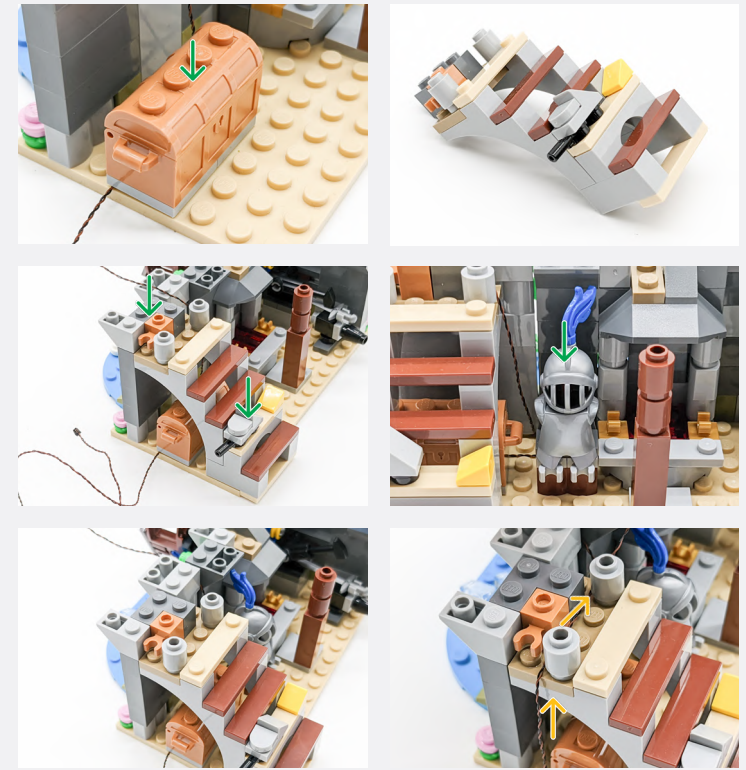

Legend

- DISCONNECT
- CONNECT / RECONNECT
- ↻ TURN / FLIP
- DIRECTIONAL
- ↻↻ TWIST / BRAID
- ✳ POWER ON TEST
- 📝 NOTE ICON

36

Bring all three cables across, including the 30cm Connecting Cable from step 30.

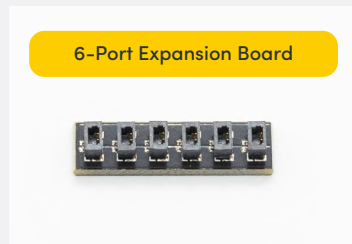
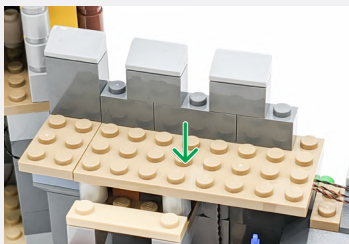
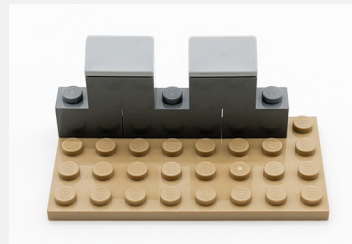

Connect the 30cm Connecting Cable and the Cool White Bit Light (shortest cable) to the 6-Port Expansion Board.

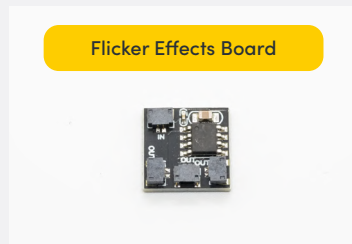
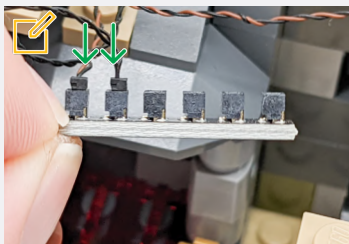

Connect the remaining Bit Light cable to the "OUT" port of the Flicker Effects Board.

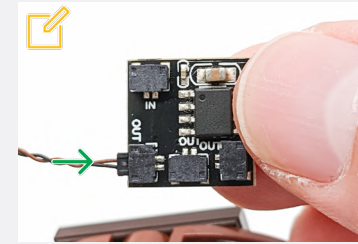

Connect the 5cm Connecting Cable to the "IN" port of the Flicker Effects Board.

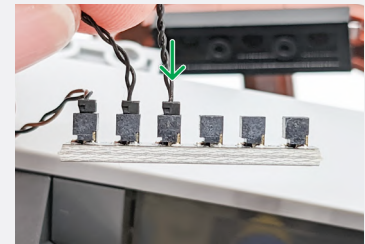
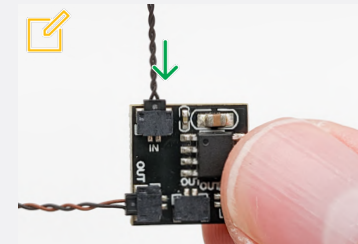

2x Adhesive Squares



Only twist the 30cm Connecting Cable.

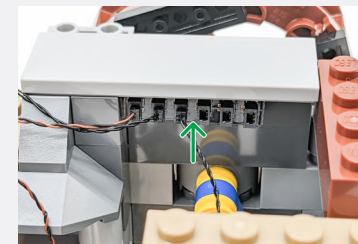

Legend → DISCONNECT → CONNECT / RECONNECT ↻ TURN / FLIP → DIRECTIONAL ↻ TWIST / BRAID ✨ POWER ON TEST 📝 NOTE ICON

📌 If you experience any issues with the lights not working and suspect an issue with a component, please try a different port on the expansion board to verify where the fault lies (with the light or expansion board). To correct any issues with expansion board ports, please view the section addressing expansion board issues in our troubleshooting section.



37



38

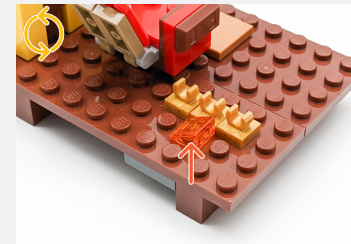

White 30cm Bit Light

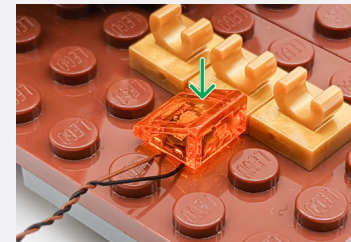
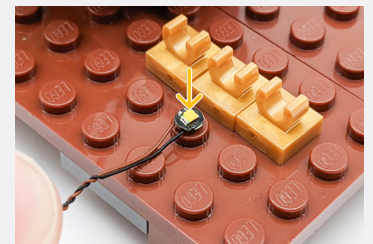

Legend

- DISCONNECT
- CONNECT / RECONNECT
- ↻ TURN / FLIP
- DIRECTIONAL
- ↻ TWIST / BRAID
- ☀️ POWER ON TEST
- 📌 NOTE ICON

39



White 30cm Micro Bit Light

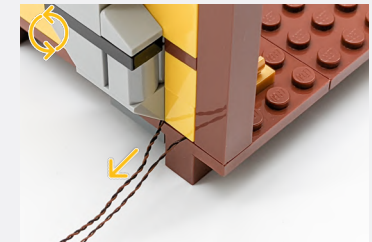
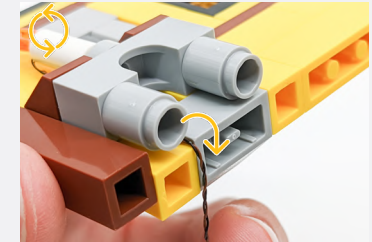
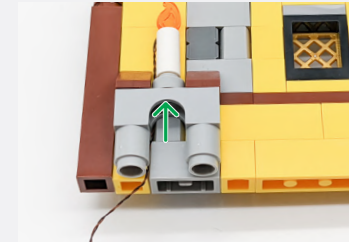
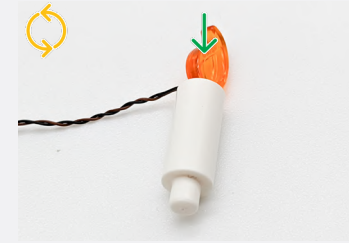
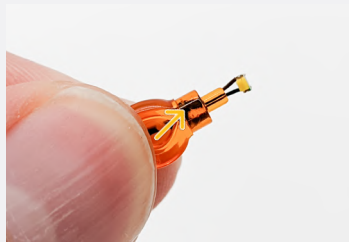
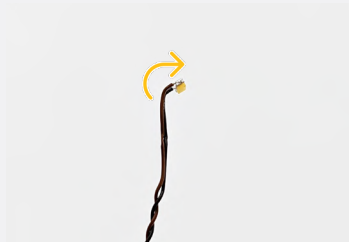

Legend

- DISCONNECT
- CONNECT / RECONNECT
- TURN / FLIP
- DIRECTIONAL
- TWIST / BRAID
- POWER ON TEST
- NOTE ICON

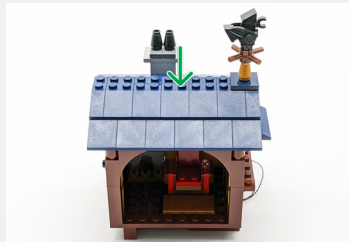
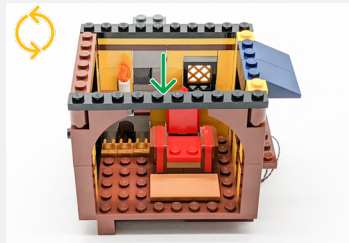

Micro 4-Port Expansion Board

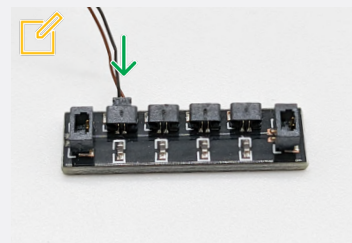

5cm Connecting Cable

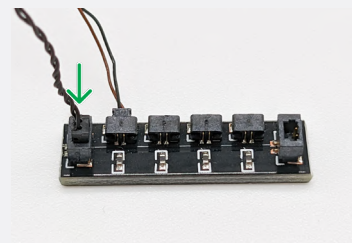
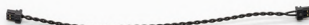

40

Connect the Micro Bit Light cable to the Micro Expansion Board.

2x Adhesive Squares

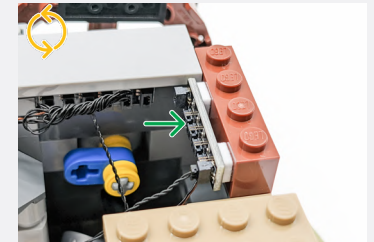

Connect the 5cm Connecting Cable and White 30cm Bit Light cable to the "OUT" port of the Flicker Effects Board.

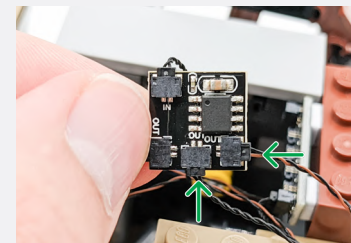

2x Adhesive Squares

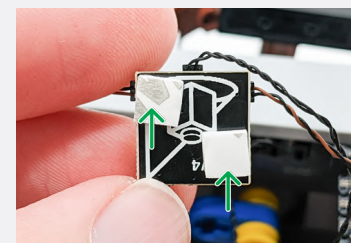

Legend

- DISCONNECT
- CONNECT / RECONNECT
- TURN / FLIP
- DIRECTIONAL
- TWIST / BRAID
- POWER ON TEST
- NOTE ICON

If you experience any issues with the lights not working and suspect an issue with a component, please try a different port on the expansion board to verify where the fault lies (with the light or expansion board). To correct any issues with expansion board ports, please view the section addressing expansion board issues in our troubleshooting section.

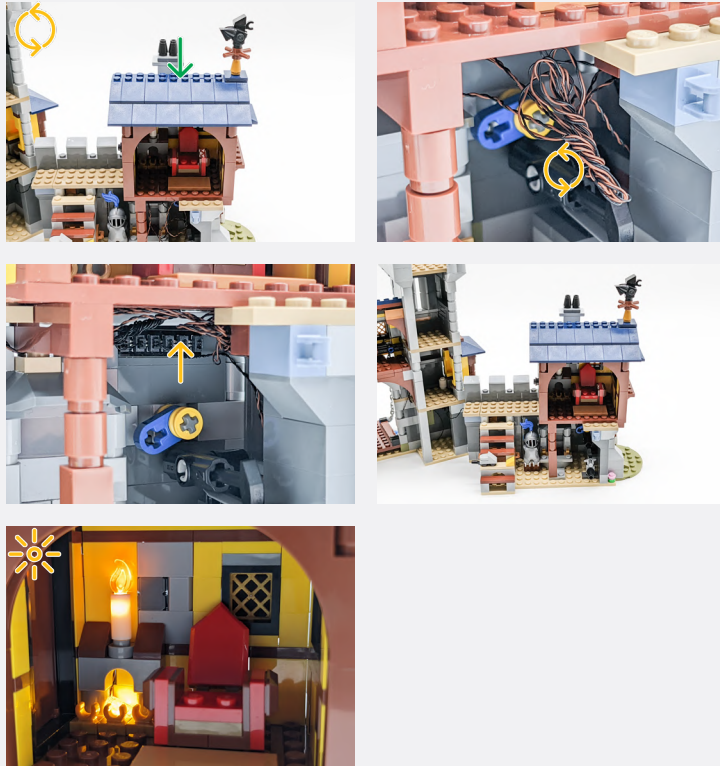

Legend
 DISCONNECT
 CONNECT / RECONNECT
 TURN / FLIP
 DIRECTIONAL
 TWIST / BRAID
 POWER ON TEST
 NOTE ICON

FINAL PRODUCT

This finally completes installation of the Light My Bricks Medieval Castle 31120 Light Kit.

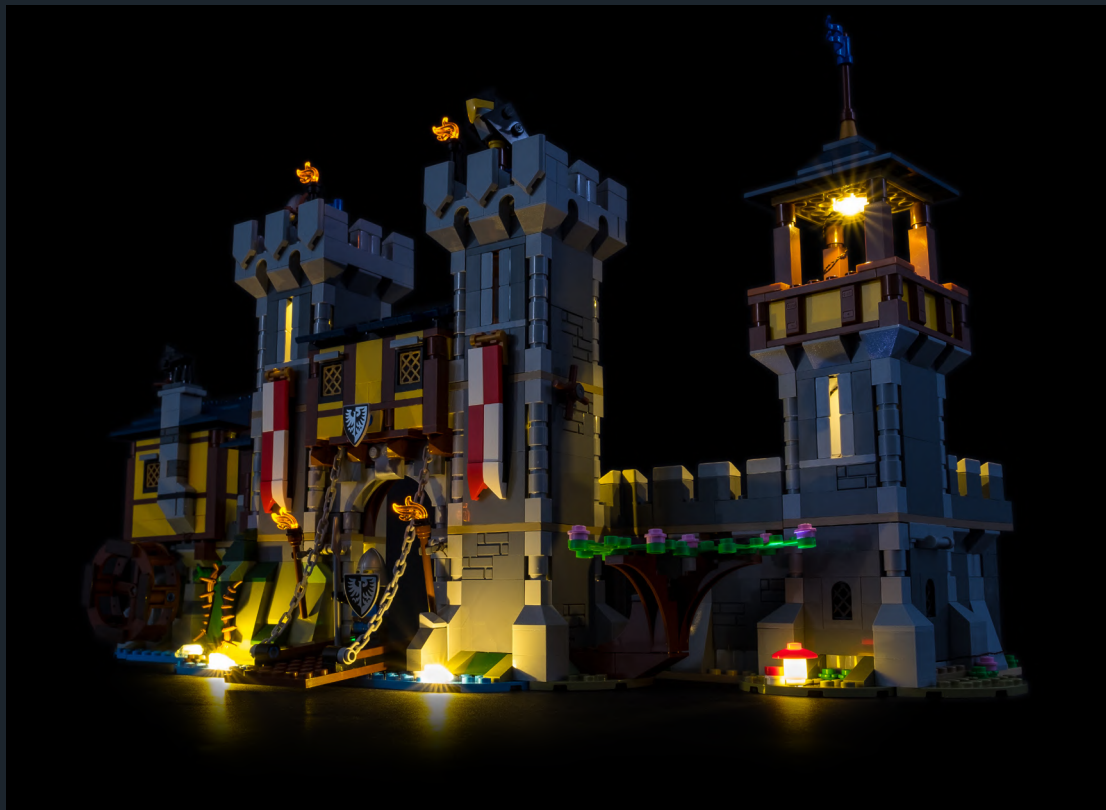



TROUBLESHOOTING

Light My Bricks lighting kits contain individual components that are very small and can be easily damaged if not handled correctly.

To prevent unnecessary damage to components, we highly recommend that the User Guide section, **“Important things to note”** is read carefully. Follow the handling procedures in the User Guide to help prevent faults and damages to your Light My Bricks components.

If you are experiencing issues with your Light My Bricks set, watch our troubleshooting video or read on for a list of common causes to help you troubleshoot.

Troubleshooting

Firstly, ensure that the batteries have power using a battery charge gauge.

If the batteries have no power, replace the batteries.

If the batteries still have power, check to see if the batteries have been inserted correctly into the battery pack.

Check For CR2032 Batteries Using The Flat Battery Pack

Inside the battery pack is a symbol indicating which side the (round) CR2032 battery should be inserted. Check that the “+” side of the battery pack has the battery with the “+” symbol facing downwards.

On the opposite side, the “-” side of the battery pack should have the battery flipped upside down, that is the “+” symbol facing upwards.

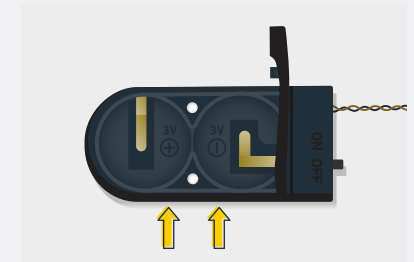

Troubleshooting

Check For Cr2032 Batteries Using The Round Battery Pack

Inside the battery pack is a symbol indicating which side the (round) CR2032 battery should be inserted. In this case, for the stacked battery pack, ensure that BOTH batteries have the “+” symbol facing upwards.

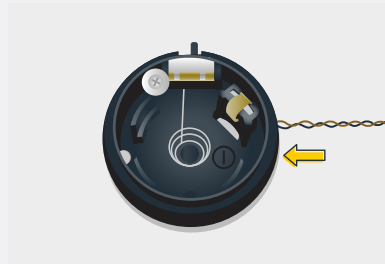

Check for AA batteries using the AA battery pack

Inside the battery pack are symbols indicating which direction the AA battery should be inserted. The flat side of the battery should be paired with the spring side of the battery pack.

If the batteries have been installed correctly and your kit still isn't operating correctly, the next step is to check the wiring.

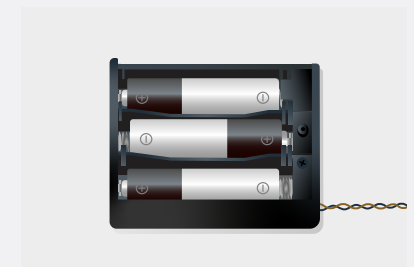
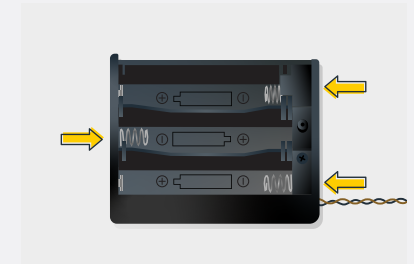

Troubleshooting

Check Your Wires

In order for Light My Bricks components to fit in between and underneath LEGO® bricks, the components need to be very small. Due to this nature, Light My Bricks components can be easily damaged when not handled correctly.

Be careful when removing unpacked components out of the packaging and ensure not to forcibly pull at the wires as this can damage the soldering that attach the wires to the LEDs.

If the wiring is detached from the LED itself, the light will not operate.

When connecting lights to your LEGO set, check that there are no pinched wires underneath or in between bricks and plates. When the wires are pinched and the exposed wires are touching each other, this can cause a crosswire and the lights to not function correctly.

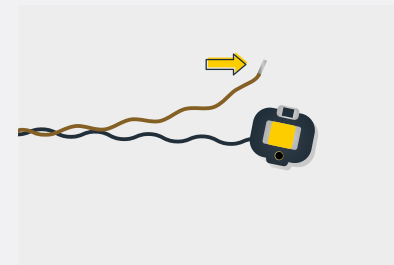
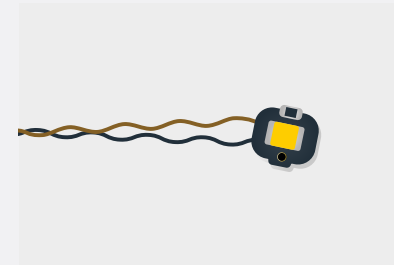

Troubleshooting

Check Your Expansion Board Ports/ Strip Light Ports / Effects Board Ports

It is important to note that connectors can only be inserted to the expansion board, strip light, or effects board ports in one direction.

Forcibly inserting connectors in the incorrect direction will result in damaging the pins inside each of the ports on your component board.

Not only will a light connected to the damaged port not work, but if the pins inside the port are bent to a point they are touching each other, this can result in all other lights in the system to stop working. This is a short circuit.

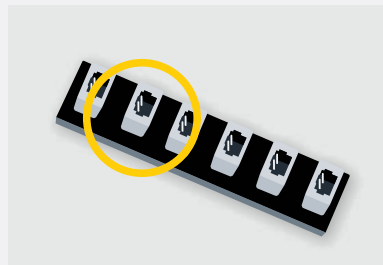

A short circuit can also result in overheating of the board, cable or batteries. If you suspect a short circuit, **DISCONNECT POWER IMMEDIATELY**. Batteries can fail, catch fire, or even explode if left connected to a short circuit for too long.

If you suspect you have a faulty component due to a bent pin, try the following steps:

If you look carefully inside each of the ports, each port contains 2 small pins that should be straight. You will be able to identify a faulty port if it has any bent pins.

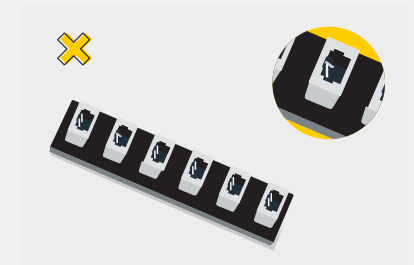
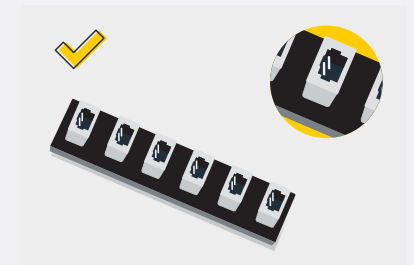
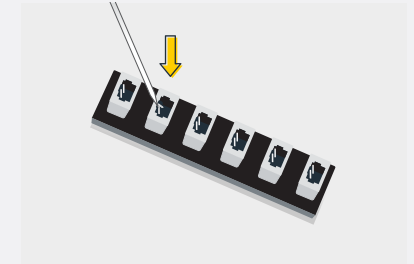



CONTACT US

If you have an enquiry regarding the online shop, our products or a general enquiry please refer to our Frequently Asked Questions webpage.

Alternatively, you can contact our Customer Services team by visiting our online support portal.

support.lightmybricks.com

We thank you for purchasing this product and hope you enjoy!



lightmybricks.com